



### MORSA **midi** e **midiplus**

Per il sistema **midi/midiplus** sono state realizzate due tipologie di morse: la morsa **midi** e la morsa **midiplus**.

Entrambe devono essere posizionate obbligatoriamente sui profili di rinforzo per creare un ponte tra i pannelli allineandoli e serandoli tra di loro.

**1** La morsa **midi**, con una lunghezza di 40 cm, oltre alla chiusura permette e garantisce la coplanarietà e l'allineamento dei pannelli. Il cuneo permette, con un colpo di battuta di

martello, di liberare le morse anche nelle zone anguste. Attraverso il cuneo frontale invece l'apertura risulta semplificata nel caso di posizionamento della morsa ad angolo.

**2** La morsa **midiplus**, con una lunghezza di 60 cm, permette e garantisce la chiusura e coplanarietà dei pannelli. Il cuneo offre due punti di battuta al martello per liberare le morse.

Il bullone di bloccaggio del cuneo permette l'eventuale sostituzione di parti danneggiate.

Riguardante il numero degli accessori utili vedi pag.126.

### KEILSCHLOSS **midi** UND KEILSCHLOSS **midiplus**

Es sind zwei verschiedene Keilschlösser für die System **midi/midiplus** verfügbar: das Keilschloss **midi** und das Keilschloss **midiplus**

Die Keilschlösser sind auf Höhe der Sprossenprofile anzuordnen um die Wandelemente miteinander bündig zu verbinden, auszurichten und dicht zu verschließen.

**1** Das Keilschloss **midi** mit seiner Länge von 30cm garantiert neben der dichten Verbindung die Bündigkeit und das fluchtende Ausrichten der Wandelemente. Auch in beengten Situationen kann das

Keilschloss dank der speziellen Geometrie des Keils problemlos geschlossen/geöffnet werden. Das Öffnen mittels frontalen Hammerschlags kommt einem insbesondere in Situationen von Innenecken entgegen.

**2** Das Keilschloss **midiplus** mit seiner Länge von 60cm garantiert die dichte Verbindung, die Bündigkeit und das fluchtende Ausrichten der Wandelemente. Der Keil bietet zwei Schlagflächen für das Schließen/Öffnen mittels Hammerschlag. Bei eventueller Beschädigung können Einzelteile des Keilschlössers problemlos ausgetauscht werden.

Bzgl. der erforderlichen Anzahl von Zubehörteilen siehe S.126.

### **midi** CLAMP and **midiplus** CLAMP

For the **midi/midiplus** system two kinds of clamps have been produced: the **midi** clamp and the **midiplus** clamp.

Both must be placed on the reinforcing sections to create a bridge between the panels aligning and clamping them.

**1** As well as clamping the panels, the **midi** clamp, with a length of 40 cm, also guarantees the coplanarity and the alignment of the panels. The clamps can be freed by striking the wedge once with a hammer even in the most cramped working areas. The use of an

angle clamp simplifies opening of the clamp by means of the front wedge.

**2** The **midiplus** clamp, with a length of 60 cm, allows clamping and the coplanarity of the panels. The wedge has two hammer hitting points for freeing the clamps. The wedge lock bolt allows the replacement of damaged parts, when necessary.

For the many useful accessories see page 126.

### PINCE **midi** et PINCE **midiplus**

Pour les systèmes **midi/midiplus** ont été réalisés deux typologies de pince: la pince **midi** et la pince **midiplus**.

Toutes les deux doivent être positionnées obligatoirement sur les profils de renfort pour bien liaisonner, aligner et fermer les panneaux entre eux.

**1** La pince **midi**, avec une longueur de 30 cm, outre la fermeture permet et garantit la coplanarité et l'alignement des panneaux. Le coin permet, avec un coup de battue du

marteau, de libérer les pinces même dans les zones étroites. L'ouverture à travers la frappe à marteau frontal se fait souvent dans des coins intérieurs.

**2** La pince **midiplus**, avec une longueur de 60 cm, permet et garantit la fermeture et coplanarité des panneaux. Le coin offre deux points battus au marteau pour libérer les pinces.

Le boulon de blocage du coin permet l'eventuelle substitution des parties endommagées.

Concernant le nombre des accessoires utiles, voir page 126.

### MORSA **midi** y MORSA **midiplus**

Para el sistema **midi/midiplus** fueron realizadas dos tipos de morsas: la morsa **midi** y la morsa **midiplus**.

Los dos tipos de morsas deben ser posicionadas obligatoriamente en los perfiles de refuerzo para crear un puente entre los panels alineándolos y cerrándolos entre si.

**1** La morsa **midi** con una longitud de 40 cm, además del cerramiento permite y garantizar la planitud y la alineación de los

paneles. La cuña permite, con un golpe de martillo liberar las morsas de las zonas angostas. Por medio de la cuña frontal, en cambio, resulta simplificado el caso del posicionamiento de la morsa a ángulo.

La morsa **midiplus**, con una longitud de 60 cm, permite y garantiza el cerramiento y la planitud de los paneles. La cuña ofrece dos puntos de golpe para el martillo para liberar las morsas. El tornillo de bloqueo permite la eventual sustitución de partes con daño.

Con respecto al número de accesorios útiles ver página 126.

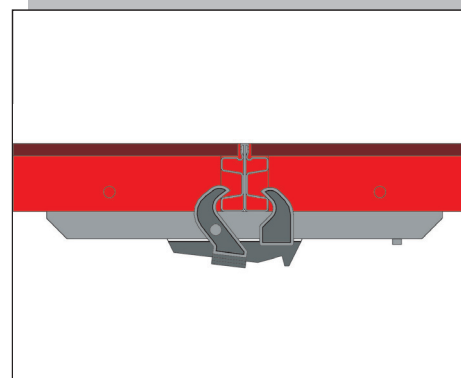
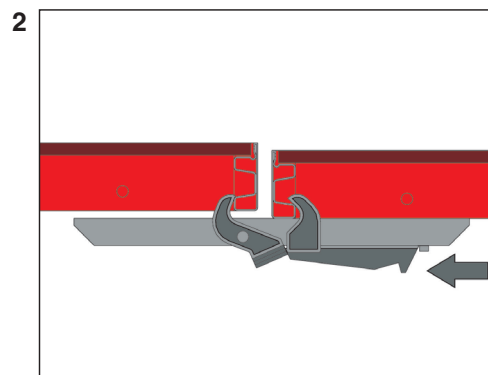
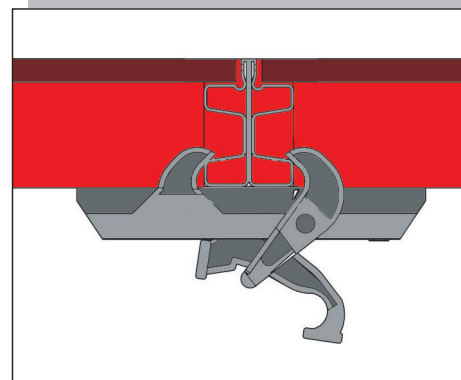
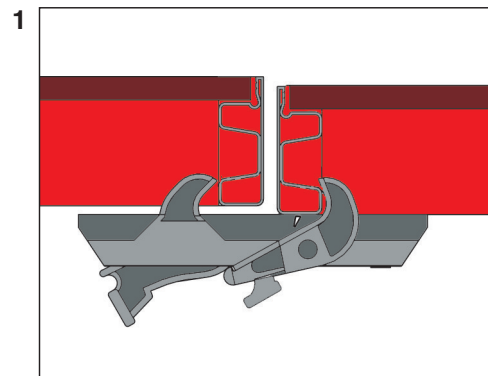

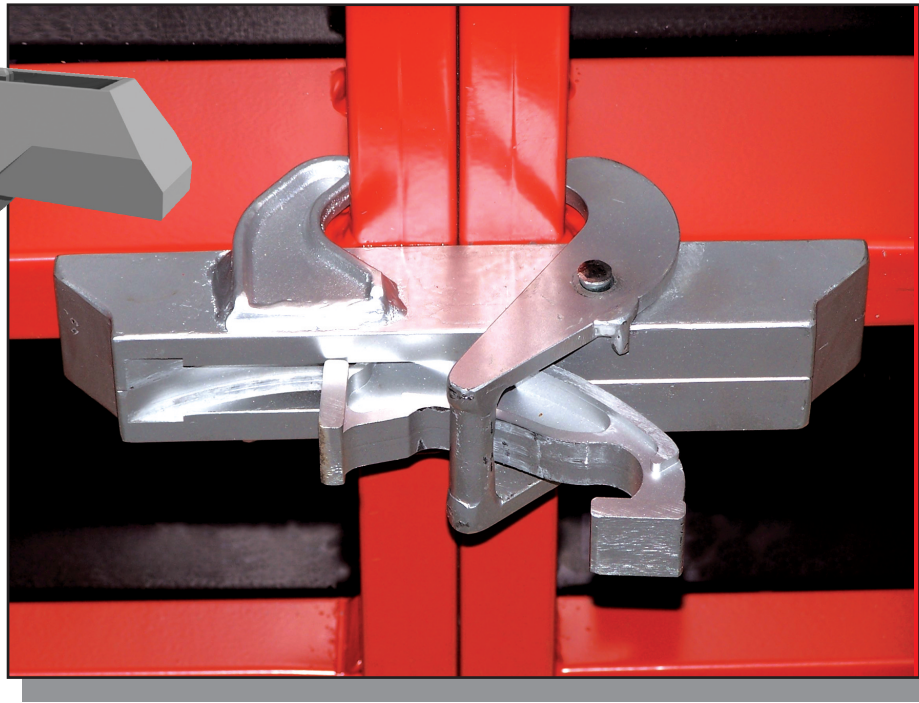
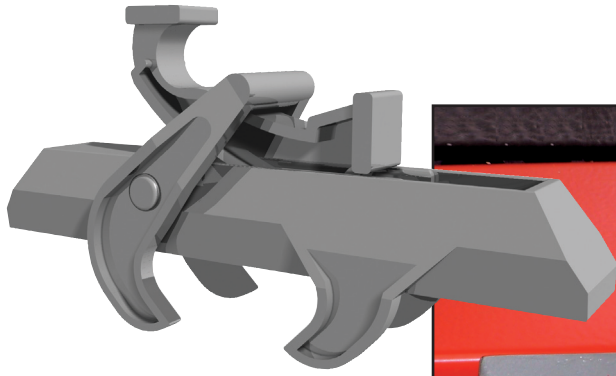

MORSA **midi/midiplus**

**midi/midiplus** KEISCHLOSS

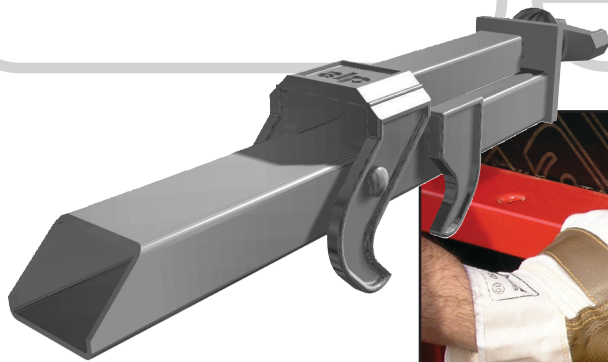

**midi/midiplus** CLAMP

PINCE **midi/midiplus**



MORDAZA **midi/midiplus**



### ELEMENTO **midi**

Il sistema **midi** è dimensionato per una pressione massima di 50 kN/mq; è imperativo rispettare le direttive sulla pressione del calcestruzzo fresco illustrate a pag. 117.

**1** La caratteristica sagomatura del profilo di bordo **midi** in acciaio, larghezza 10 cm, garantisce grande maneggevolezza e permette il posizionamento della morsa in qualsiasi punto del perimetro del telaio, un collegamento sicuro sia in verticale che in orizzontale.

**2** Manto spessore 15 mm a 11 strati marchiato **alpi**, con sigillatura perimetrale in poliuretano per agevolare le dilatazioni e la

tenuta stagna. I profili di bordo sono rinforzati dall'angolo massiccio forgiato per rendere il pannello più robusto e per facilitarne il posizionamento dal muro.

**3** Le traverse di rinforzo realizzate con profili sagomati a doppia T permettono una maggiore maneggevolezza.

**4** Le traverse con profili aperti a U con foratura multipla permettono, oltre al passaggio dei tiranti in varie posizioni, il montaggio di angoli e pilastri con sbordo del pannello (universale e pilastro)

**5** I fori conici delle boccole in plastica per il passaggio dei tiranti permettono un'inclinazione massima del pannello di 6°.

### WANDELEMENT **midi**

Die Systemschalung **midi** ist auf einen maximalen Betondruck von 50kN/m<sup>2</sup> ausgelegt. Bzgl. der normgemäßen Charakteristik des Befondrucks wird auf S.117 verwiesen.

**1** Die spezielle Profilgeometrie des Rahmenprofils in Stahl, Profilhöhe 10cm, garantiert ein Maximum an Handlichkeit und die Möglichkeit der Anbringung des Keilschlusses an jeder beliebigen Stelle. Eine sichere Verbindung sowohl der Horizontalstöße als auch der Vertikalstöße.

**2** Schalhautstärke 15mm gebildet aus 11 Schichten mit Markenkennzeichnung, umlaufende Abdichtung mit elastischer Silikonfuge. Die spezielle massive

Geometrie der Rahmenecken steht für eine höhere Robustheit und leichteres Ausrichten der Paneele.

**3** Die Geometrie der Sprossenprofile (Doppel-T) ermöglicht ein Maximum an Handlichkeit.

**4** Die als U-Profile ausgeführten Quersprossen ermöglichen mit ihrer modularen Lochung das universale Positionieren der Spannstäbe sowie die Realisierung von Außenecken oder Pfeiler mit sog. Windflügelösung.

**5** Die konischen Löcher der Plastik-Spannerhülsen ermöglichen eine maximale Neigung der Wandelemente von 6°

### **midi** PANEL

**midi** systems are designed for a maximum 50kN/m<sup>2</sup> pressure; compliance with the fresh concrete pressure requirements illustrated on page 117 is mandatory.

**1** The characteristic shape of the 10 cm. wide **midi** steel edge profile ensures easy handling of the clamp, and its placement at any point of the edge of the frame, as well as its safe, vertical, and horizontal connection.

**2** Plywood (15mm thick, 11 layers) with **alpi** logo on it, with polyurethane edge sealing to improve expansion characteristic and sealing features. The edges are reinforced by means of

a strengthened forged corner in order to make the panel more robust and to facilitate its detachment from the wall.

**3** The reinforcing secondary tie beams are produced with double-T shaped profiles to allow much easier handling.

**4** The multi-holed tie-beams with U-shaped profiles allow the passage of the tie-rods in various positions, and the mounting of corners and pillars using panels in windmill-mode.

**5** The tapered holes of the plastic bushes for the tie-rod passage allow the panel to slope up to a maximum inclination of 6° from its perfectly vertical position.

### PANNEAU **midi**

Le système **midi** est dimensionné pour une pression maximale de 50 kN/m<sup>2</sup>; il est absolument nécessaire de respecter les directives sur la pression du béton frais indiquées à la page 117.

**1** La forme caractéristique du profil de bord **midi** en acier, largeur 10 cm, garantit grande maniabilité et permet le positionnement de la pince, en n'importe quel point du périmètre du châssis, une liaison sûre aussi bien en position d'emploi vertical qu'horizontal.

**2** Peau coffrante 15 mm d'épaisseur 11 plis estampillés **alpi**, avec joint périphérique en polyuréthane pour faciliter les dilatations et

l'étanchéité. La géométrie robuste des profils de bord renforcés rend le panneau plus robuste et facilite le positionnement du panneau.

**3** Les traverses de renfort réalisées avec des profils type double T permettent une majeure maniabilité.

**4** Les traverses de renfort avec des profils en U ouverts avec perçage multiple pour le passage des tiges en position variable permettent aussi le montage des panneaux en aile de moulin pour la construction d'angles ou de poteau.

**5** Les perçages coniques des douilles en plastique pour le passage de tirant permettent une inclinaison maximale du panneau de 6°.

### ELEMENTO **midi**

El sistema **midi** està dimensionado para una presión máxima de 50 kN/m<sup>2</sup>; es obligatorio respetar las directivas sobre la presión del hormigón fresco ilustrado en la página 117.

**1** La forma característica del perfil de bordo **midi** en acero, ancho 10 cm garantiza gran movilidad y posicionamiento de la morsa en cualquier punto del perimetro del bastidor, una conexión segura horizontal o vertical.

**2** El manto de espesor 15 mm a 11 estratos marcado **alpi**, tiene un sellado perimetral en poliuretano para permitir las dilataciones y la

estabilidad.

**3** Los perfiles de bordo están reforzados con un ángulo de fundición para robustecer el panel y facilitar el posicionamiento a la pared. Los transversales de refuerzo realizados con perfiles a forma de doble T permiten una mayor maniobrabilidad.

**4** Los transversales con perfiles abiertos a U con perforaciones múltiples permiten, además del pasaje de los tirantes en varias posiciones, el montaje de ángulos e pilares.

**5** Las perforaciones cónicas de los bujes de plástico para el pasaje de los tirantes permiten una inclinación máxima de 6°.

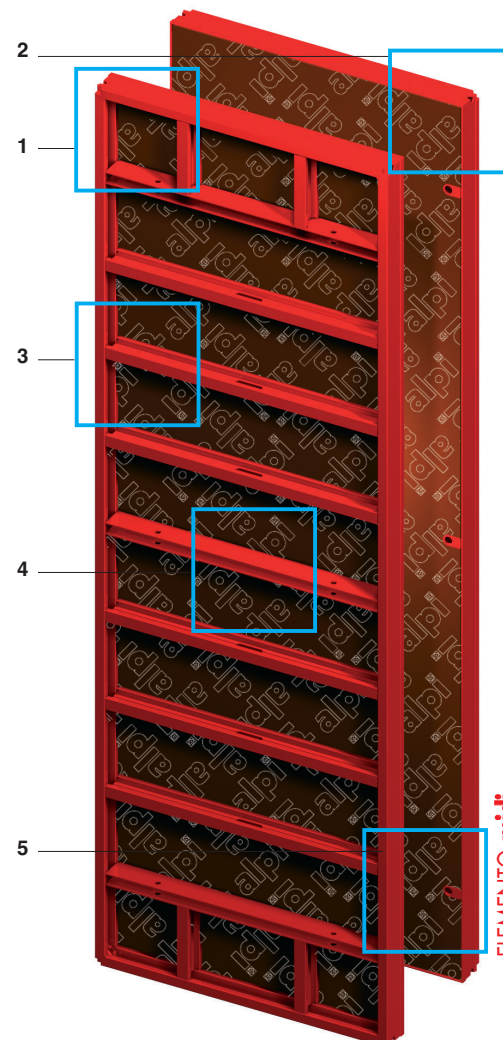

ELEMENTO **midi**



midi/midiplus

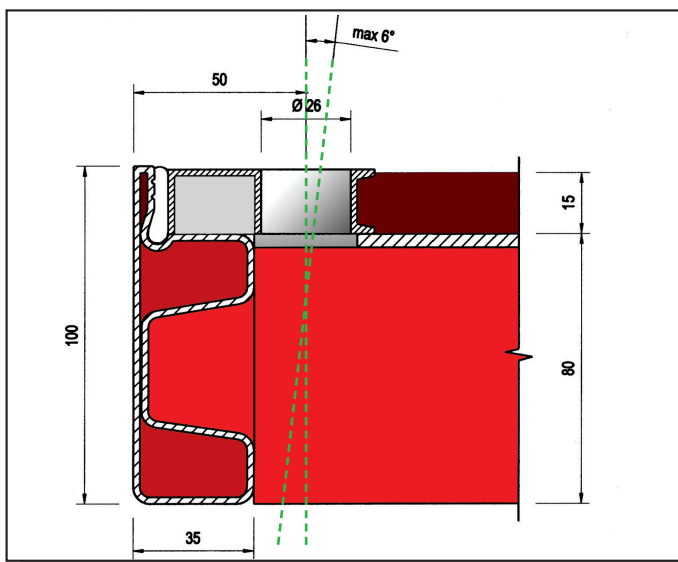
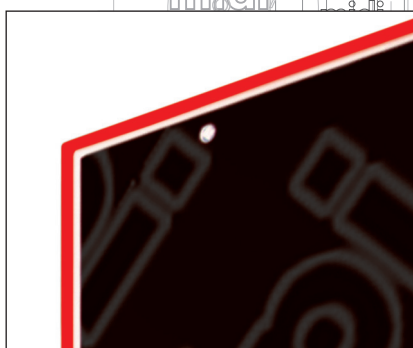
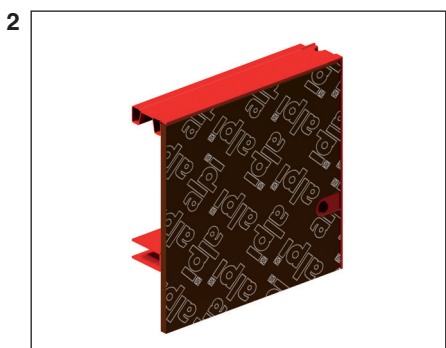

50 kN/m<sup>2</sup>

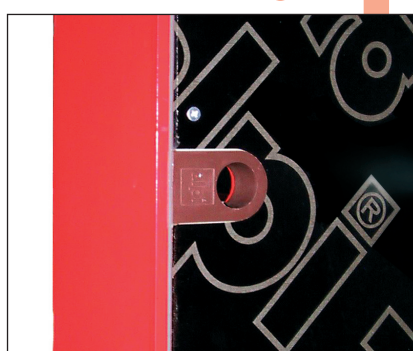
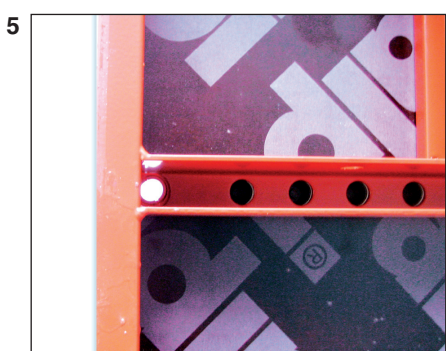

plus  
midiplus

ELEMENTO midi

midi ELEMENT

midi PANEL

PANNEAU midi

ELEMENTO midi



**COMPOSIZIONI *midi/midi alu***

1 Le dimensioni dei pannelli *midi/midi alu* sono state scelte per rendere semplici tutte le combinazioni geometriche. Sono prodotti pannelli standard che possono essere sovrapposti anche per altezze elevate, sempre nel rispetto delle pressioni di getto ammissibili.

Le dimensioni in larghezza sono multiplo del modulo 25 cm.

Pannelli con gli elementi di compensazione permettono tutti gli adattamenti possibili al progetto.

2 Dimensioni.

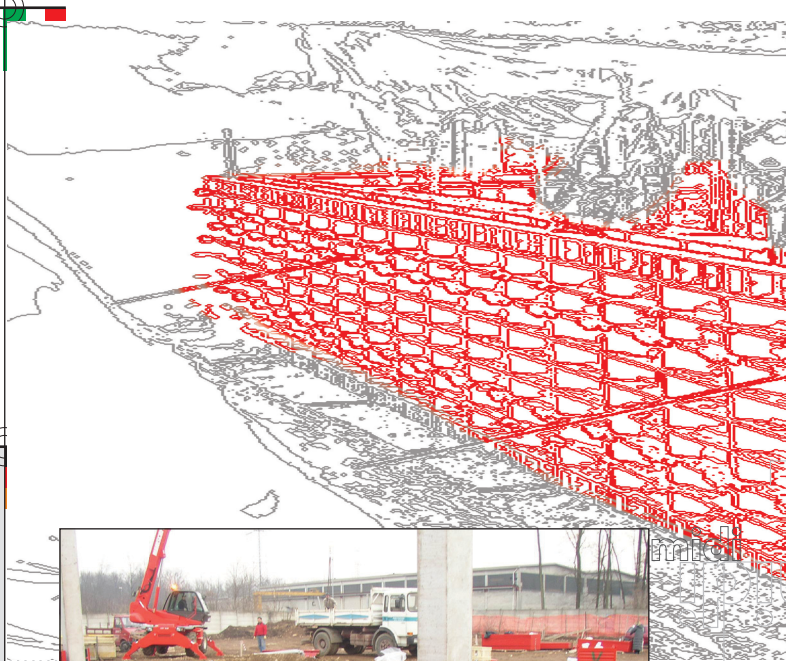

**MODULARE ZUSAMMENSTELLUNGEN *midi/midi alu***

1 Die *midi/midi alu* Elemente haben praxisbewährte Abmessungen, deren Modularität verschiedenste geometrische Zusammenstellungen ermöglicht. Selbst grosse Wandhöhen können unter Berücksichtigung des entsprechenden Betondruckes durch übereinandergestellte Standardelemente realisiert werden.

Die Elementbreiten ergeben sich aus Vielfachen eines 25 cm-Rasters.

Die Kombination der Standardelemente mit entsprechenden Ausgleichselementen ermöglicht die Anpassung der Schalung an sämtliche Geometrien.

2 Standardgrößen der Wandelemente.



***midi/midi alu* COMPOSITIONS**

1 *midi/midi alu* panel dimensions are chosen to make it easy to create a complete variety of compositions. These are standard panels that can be superposed to realize big formwork heights as long as admissible casting pressures are complied with.

Width dimensions are multiples of a 25 cm module.

Panels with compensation elements can adapt perfectly to the project.

2 Dimensions.



**COMPOSITIONS *midi/midi alu***

1 Les dimensions des panneaux *midi/midi alu* ont été choisies pour simplifier toutes les compositions géométriques. La production prévoit des panneaux standard qui peuvent être superposés pour créer de grands coffrages, en respectant toujours les pressions admissibles de bétonnage.

Les dimensions en largeur sont des multiples du module de 25 cm.

Des panneaux permettent avec les éléments de compensation toutes les adaptations possibles au projet.

2 Dimensions.



**COMPOSICIONES *midi/midi alu***

1 Las dimensiones de los paneles *midi/midi alu* han sido elegidas para simplificar todas las combinaciones geométricas. Producción de paneles estándar que pueden superponerse también para realizar grandes alturas de encofrados, respetando siempre las presiones admisibles del hormigón.

Las dimensiones en anchura son múltiplos del módulo de 25 cm.

Los paneles permiten con los elementos de compensación todas las adaptaciones posibles al proyecto.

2 Dimensiones.



***midi***

	L	200	100	90	75	70	60	55	50	45	40	30	25
H													
		300											
		150											

***midi alu***

	L	100	75	50	25
H					
		300			
		150			

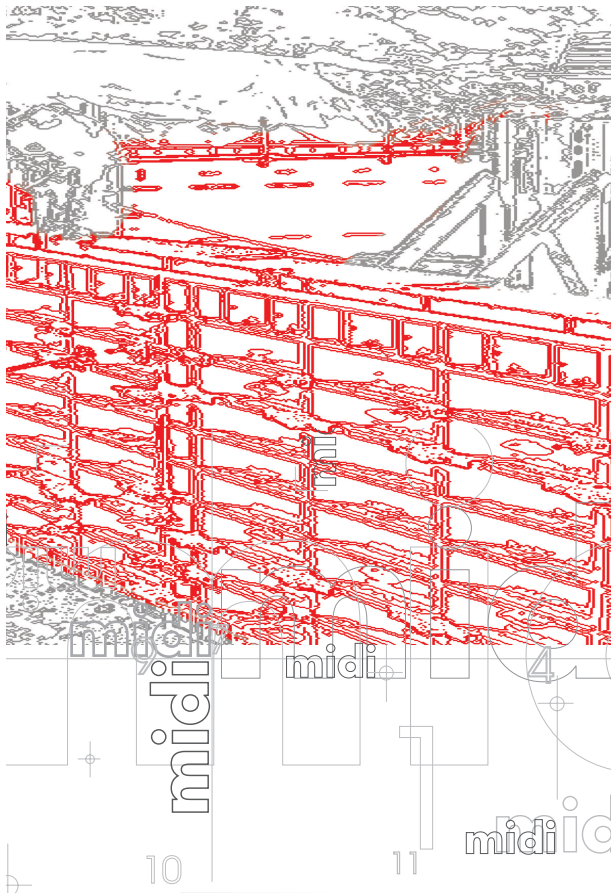

25 | 50 | 75 | 100 | 125 | 150 | 175 | 200 | 225 | 250 | 275 | 300 | 325 | 350 | 375 | 400 | 425 | 450 | 475 | 500 | 525 | 550 | 575 | 600



300 | 300 | 300 | 300 | 300 | 300 | 300 | 300 | 300 | 300 | 300 | 300 | 300 | 300 | 300 | 300 | 300 | 300 | 300 | 300 | 300 | 300

1 **midi/midiplus** mod. 25cm

COMPOSIZIONI **midi/midiplus**

MODULARE ZUSAMMENSTELLUNGEN  
**midi/midiplus**

COMPOSITIONS **midi/midiplus**

COMPOSICIONES **midi/midiplus**

COMPOSICIONES **midi/midiplus**



### ANGOLO INTERNO 90°

**1** Gli angoli retti interni **midi** o **midi-plus**, interamente in acciaio, sono utilizzati per costruire raccordi a 90° oppure a "T".

L'angolo retto interno di 30 cm di lato può ricevere morse diritte oppure morse a vite, montate nella loro posizione ideale nel prolungamento dei profili di rinforzo di ogni pannello adiacente, in modo da garantire il perfetto allineamento.

**2** Per adattare il cassero ai vari spessori dei setti si inseriscono tra gli angoli ed i pannelli le aste di compenso (o murali in legno). Il serraggio avviene con le morse a vite **3**.

**4** La spinta del getto viene trasmessa sul tirante tramite i traversini di compenso.

Riguardante il numero degli accessori utili vedi pag.116/126.



### 90° INNENECK

**1** Für die Ausführung von 90°-Wanddecken oder T-förmigen Wandanschlüssen ist das **midi** oder **midiplus** 90°-Inneneck aus Stahl vorgesehen.

Das Inneneck mit der Kantenlänge von jeweils 30 cm kann sowohl mittels normalem Keilschloss als auch mittels Schraubzwinde mit den angrenzenden Elementen verbunden werden.

Um eine optimale fluchtende Ausrichtung zweier benachbarter Elemente zu garantieren, muss das 60 cm lange Keilschloss in

Achse einer Querstrebe der Elemente angeordnet werden;

**2** Um auf beliebige Wandgeometrien zu reagieren, werden eventuelle Restmaße durch Verwendung von Ausgleichsstab (oder Holzausgleich) kompensiert. Die Verbindung erfolgt mittels Schraubzwinde **3**.

**4** Der Betondruck wird über die Ausgleichsriegel auf die Spannstäbe übertragen.

Bzgl. der Anzahl der erforderlichen Zubehörteile siehe bitte S.116 bzw. S126.



### 90° INTERNAL CORNER

**1** **midi** or **midiplus** internal corner, made entirely out of steel, used to realize 90°-corners or "T" connections.

The internal corner (30 cm length of edge) can carry straight clamps or adjustable clamps mounted in the ideal position along the secondaries or stiffeners of each adjacent panel to ensure perfect alignment.

**2** Filler bars (or timbers) are inserted between corners and panels to adapt the formwork to different thicknesses of wall.

Clamping is achieved by means of adjustable clamps **3**.

**4** The concrete cast pressure is distributed on the tie-rod by means of the compensatory joint plates.

Refer to page 116/126 for the number of useful accessories.



### ANGLE INTERIEUR 90°

**1** Les angles droits intérieurs **midi** ou **midiplus**, entièrement en acier, sont utilisés pour construire des raccords en angle à 90° ou en "T".

L'angle droit intérieur de 30 cm de côté peut recevoir des pinces droites ou bien des pinces à vis, montées dans la position idéale dans le prolongement des profilés de renfort de chaque panneau adjacent de façon à en garantir l'alignement parfait.

**2** Pour adapter le coffrage aux différentes géométries des murs on introduit les tôles de compensation (ou des compensations en bois) pour compenser les distances. Le serrage se fait avec les pinces à vis **3**.

**4** La poussée du béton est transmise sur le tirant par les aligneurs de compensation.

Pour le nombre d'accessoires utiles, Cf. page 116/126.



### ANGULO INTERIOR 90°

**1** Los ángulos rectos interiores **midi** o **midiplus**, totalmente en acero, son utilizados para construir uniones a 90° o en "T".

El ángulo recto interior de 30 cm de lado puede recibir mordazas rectas o mordazas de tornillo, colocándolas en su posición ideal a lo largo de los perfiles de refuerzo de cada panel adyacente, garantizando así una perfecta alineación.

**2** Para adaptar el encofrado a los varios espesores, se introducen entre los ángulos y los paneles una varilla de compensación (o un mural de madera). El cerramiento se hace con la morsa a tornillo **3**.

**4** La presión de hormigonado se transmite al tirante por intermedio de los travesaños de compensación.

Por lo que se refiere al número de accesorios, véase le pag. 116/126.

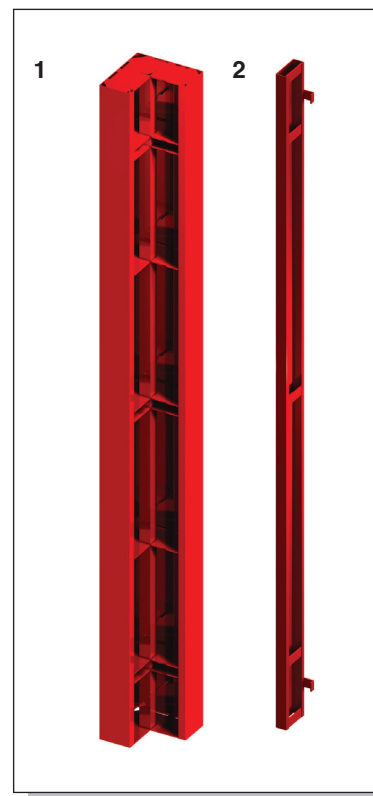

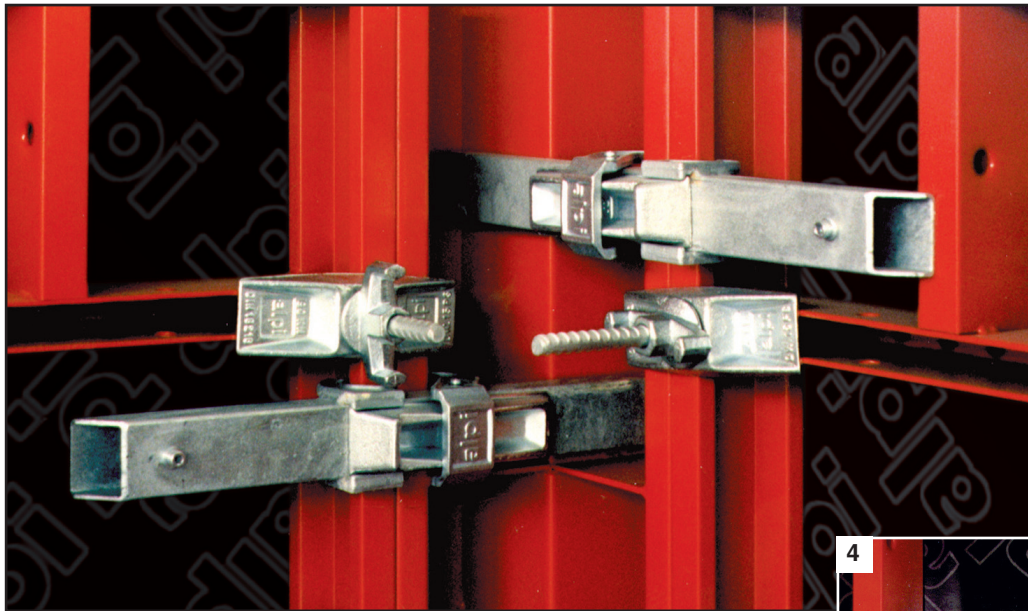

3

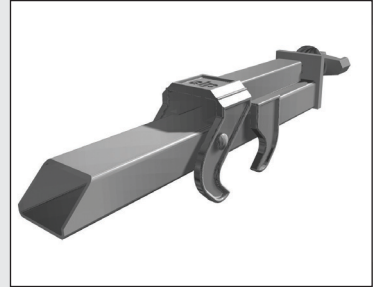

4

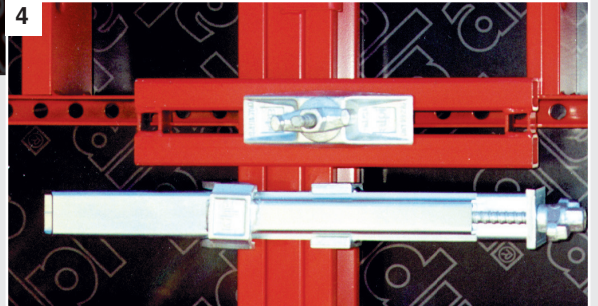

ANGOLO INTERNO 90°

90° INNENECK

90° INTERNAL CORNER

ANGLE INTERIEUR 90°

ANGULO INTERIOR 90°

**midi**

**midiplus**

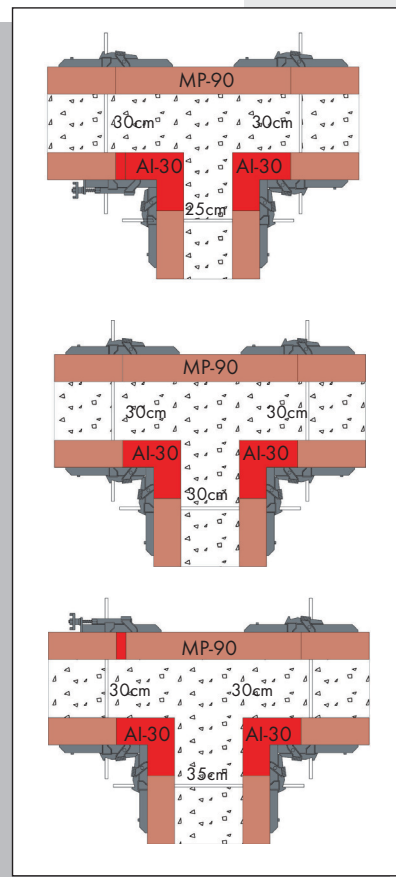
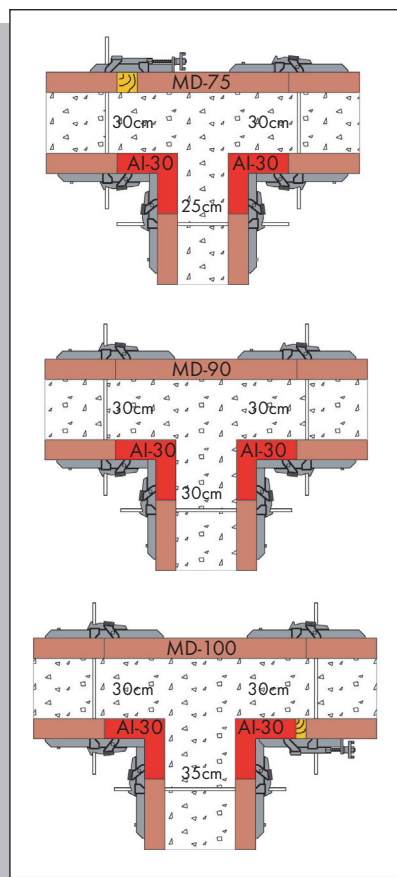





### ANGOLO ESTERNO 90°

**1** Gli angoli retti esterni **midi** o **midi-plus**, interamente in acciaio, sono utilizzati per costruire raccordi a 90°.

L'angolo è collegato ai pannelli con morse diritte montate in posizione alternata, mentre **2** le aste di compenso permettono l'adattamento ai vari spessori dei muri.

**3** Il collegamento a 90° può anche essere realizzato utilizzando pannelli con profili a foratura multipla bloccandoli con le chiavi pilastro. In questo modo si evitano spesso le compensazioni esterne per adattare la cassaforma ai vari spessori dei setti.

Riguardante il numero degli accessori utili vedi pag.116/126.

### 90° AUSSENECK

**1** Für die Ausführung von 90°-Wandecken ist das **midi** oder **midi-plus** 90°-Ausseneck aus Stahl vorgesehen.

Das Ausseneck wird mittels Keilschloss, welches in der Höhe alternierend montiert wird, mit den angrenzenden Elementen verbunden.

**2** Um verschiedene Wandstärken zu realisieren, können im Bedarfsfall Ausgleichsstäbe aus Stahl oder Holz vorgesehen werden.

**3** Mit Hilfe der Universalelemente kann eine Aussenecksituation alternativ mittels der sog. Windmühle realisiert werden; hierbei steht eines der beiden zusammenstossenden Wandelemente über die Kante hinaus. Die Verbindung der aufeinanderstossenden Wandelemente erfolgt mittels Pfeilerkralle. Diese Lösung ermöglicht den Verzicht auf Ausgleichsstäbe, welches aus ästhetischen Gründen oftmals gewünscht werden.

Bzgl. der Anzahl der erforderlichen Zubehörteile siehe bitte S.116 bzw. S126.

### 90° EXTERNAL CORNER

**1** **midi** or **midi-plus** external corner, made entirely out of steel, used to realize 90°-corners.

The corner is connected to the panels using the straight clamps mounted in an alternated position and **2** the filler bars permit adaptation to different wall thicknesses.

**3** The 90° connection can also be realized using universal panels in windmill-mode, clamping them with the column coupler. This often prevents the need for external compensations to adapt the formwork to different wall thicknesses.

Refer to page 116/126 for the number of useful accessories.

### ANGLE EXTERIEUR 90°

**1** Les angles droits extérieurs **midi** ou **midi-plus**, entièrement en acier, sont utilisés pour construire des raccords en angle à 90°.

L'angle est relié aux panneaux par des pinces droites montées en position alternée, tandis que **2** les tiges de compensation permettent l'adaptation aux différentes épaisseurs des murs.

**3** La liaison à 90° peut aussi être réalisée avec des panneaux en exploitant les traverses multiperçage pour la liaison entre eux au moyen des clés pour poteau.

De cette façon on évite souvent les compensations extérieures pour adopter le coffrage aux différentes épaisseurs des voiles.

Pour le nombre d'accessoires utiles, Cf. page 116/126.

### ANGULO EXTERIOR 90°

**1** Los ángulos rectos exteriores **midi** o **midi-plus**, totalmente en acero, son utilizados para construir uniones a 90°.

El ángulo está conectado con los paneles por medio de mordazas rectas montadas en posición alternada, mientras que **2** las varillas de compensación permiten la adaptación a los diferentes espesores de los muros.

**3** La unión a 90° puede ser también realizada utilizando paneles con perfiles de agujeros múltiples bloqueándolos con las llaves de pilar.

De esta manera es a menudo posible evitar las compensaciones exteriores para adaptar el encofrado a los diferentes espesores de los tabiques.

Por lo que se refiere al nombre de accesorios, véase le pág. 116/126.

### midi

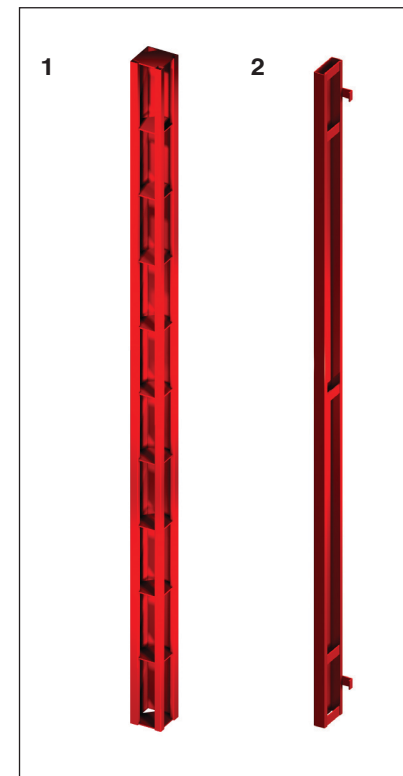
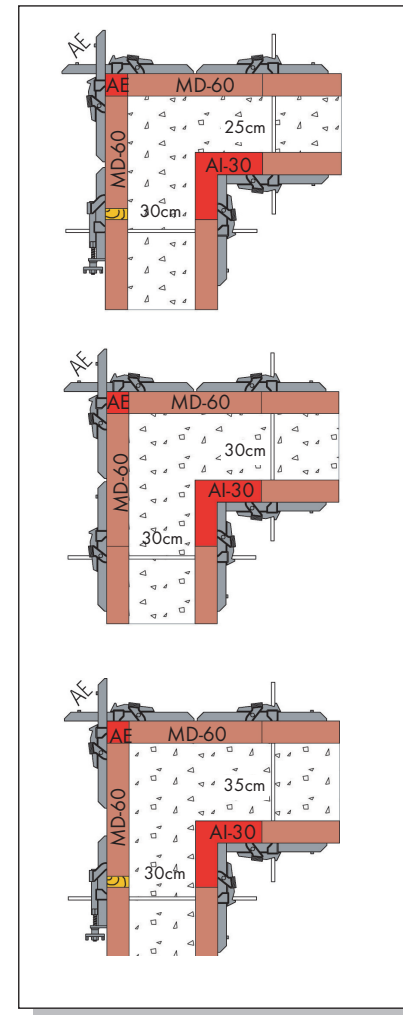



**midiplus**

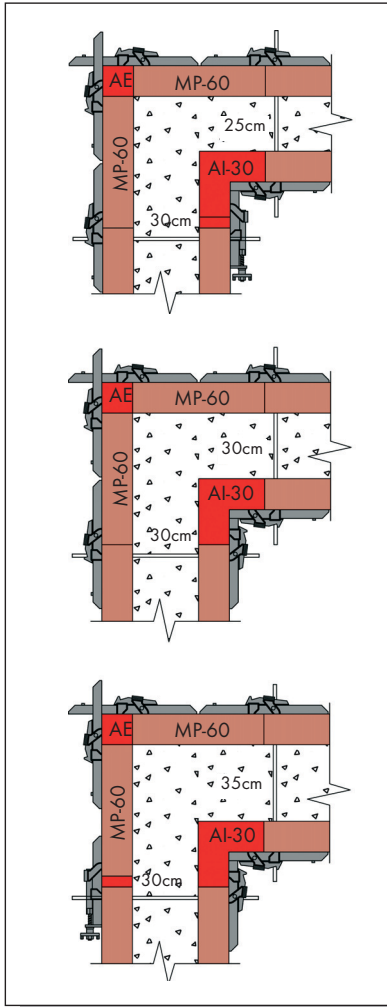

ANGOLO ESTERNO 90°

90° AUSSENCK

90° EXTERNAL CORNER

ANGLE EXTERIEUR 90°

ANGULO EXTERIOR 90°



**midiplus**

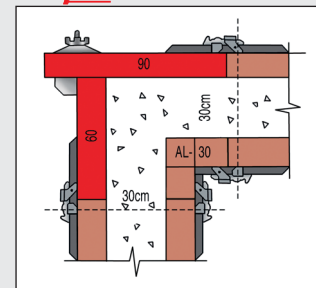

**midi**

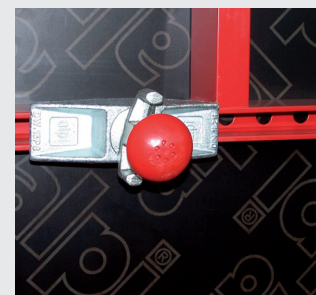
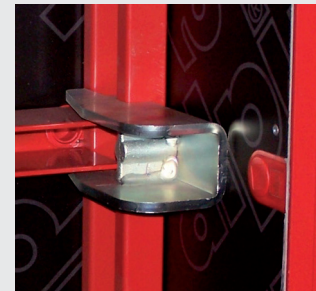



## ANGOLI SNODATI

**1** L'angolo interno snodato **midi** o **midiplus** costituito da 2 lati da 30 cm varia da 60° a 180°.

**2** L'angolo esterno snodato **midi** o **midiplus** varia da 0° a 180°. I due angoli contrapposti consentono di gettare un muro da 30 cm di spessore a 135° senza l'impiego di compensazioni. Per gli altri spessori si inseriscono delle compensazioni tra gli angoli ed i pannelli adiacenti.

Il collegamento con i pannelli adiacenti avviene con morse diritte oppure a vite per garantire l'allineamento.

Riguardante il numero degli accessori utili vedi pag.116/126.



## BEWEGLICHE ECKE

**1** Das bewegliche **midi** oder **midiplus**-Inneneck ist im Bereich von 60° bis 180° beliebig verstellbar; die jeweilige Kantenlänge beträgt 30 cm.

**2** Mit der Aussen-Gelenkecke **midi** oder **midiplus** können Wandwinkel von 0°-180° realisiert werden. Bei einer Wandstärke von 30cm und einem Winkel von 135° ist kein Einsatz von Längenausgleichen erforderlich. Bei anderen Wandstärken/Winkel sind entsprechende Längenausgleiche vorzusehen

Um die Ausrichtung zu garantieren, werden benachbarte Wandelemente mit dem Keilschloss oder der Schraubzwinge verbunden.

Bzgl. der Anzahl der erforderlichen Zubehörteile siehe bitte S.116 bzw. S126.



## HINGE CORNERS

**1** The **midi** or **midiplus** internal hinge corner is composed of two 30 cm wide boxes. It can vary from 60° to 180°.

**2** The **midi** or **midiplus** external hinge corner can vary from 0° to 180°. The two opposing corners allow the casting of a 30 cm thick wall with an angle of 135° without any additional compensation. In case of other thicknesses and different corners some compensations are inserted between corners and adjacent panels.

To ensure the proper alignment between the hinge corner and the adjacent panels clamps or adjustable clamps must be used.

Refer to page 116/126 for the number of useful accessories.



## ANGLES ARTICULÉS

**1** L'angle intérieur articulé **midi** ou **midiplus**, constitué de 2 côtés de 30 cm, varie de 60° à 180°.

**2** L'angle extérieur articulé **midi** ou **midiplus** varie de 0° à 180°. Les deux angles opposés permettent de couler une voile de 30 cm d'épaisseur à 135° sans l'utilisation de compensations. Pour les autres épaisseurs/angles il faut intercaler des compensations entre les angles et les panneaux.

La liaison avec les panneaux adjacents fait à l'aide de pinces au pince à vis pour garantir l'alignement.

Pour le nombre d'accessoires utiles, Cf. page 116/126.



## ANGULOS ARTICULADOS

**1** El ángulo interior articulado **midi** o **midiplus**, constituido de 2 lados de 30 cm, varía de 60° a 180°.

**2** El ángulo externo articulado **midi** o **midiplus** varía de 0° a 180°. Los dos ángulos puestos en oposición permiten hormigonar una pared de 30 cm de espesor a 135° sin emplear compensadores. Para otros espesores/ángulos se introducen compensadores entre los ángulos y los paneles adyacentes.

La conexión con los panels adyacentes se hace con una morsa o con tornillos para garantizar la alineación.

Por lo que se refiere al número de accesorios, véase le pág. 116/126.





1

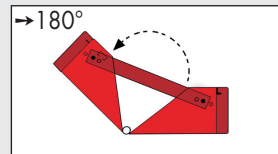
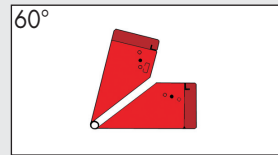
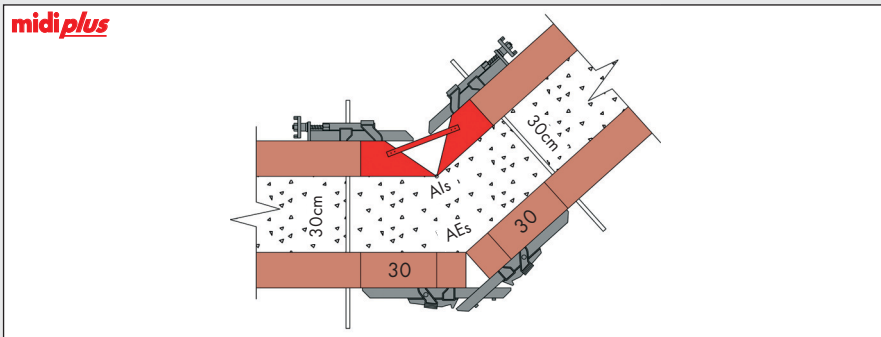
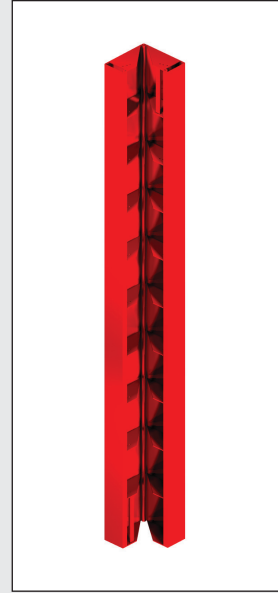

ANGOLI SNODATI

BEWEGLICHE ECKE

HINGE CORNERS

2

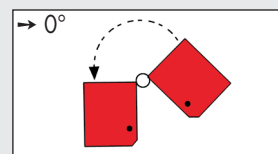
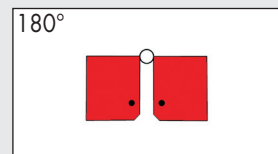
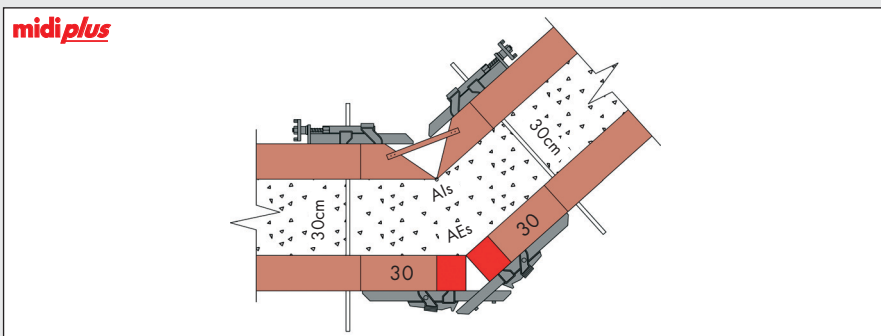
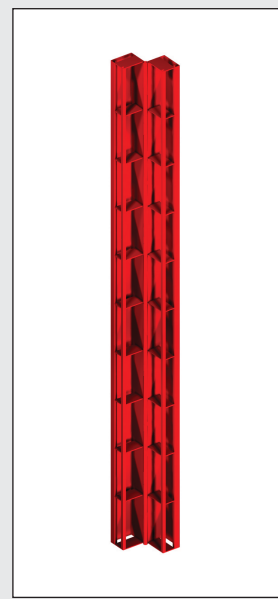

ANGLES ARTICULÉS

ANGULOS ARTICULADOS



## PILASTRO

**1** Grazie alle traverse di rinforzo a foratura multipla si possono assemblare i pannelli **midi** o **midiplus** ad ala di mulino per formare casseforme per pilastro.

**2** Il collegamento tra i pannelli avviene tramite chiavi per pilastro **midi** o **midiplus**.

**3** Con pannelli **midi** da 100 cm (pannello pilastro) si possono gettare pilastri fino a 75 cm con intervalli di 5 cm con pannelli **midiplus** da 90 cm pilastri fino a 65 cm.

**4** Dimensioni dei pilastri.

## PFEILER

**1** Durch die in den **midi** oder **midiplus** Universal-Wandelementen vorgesehenen durchgängig gebohrten Querstreben können Pfeiler nach dem Windflügelprinzip geschalt werden.

**2** Die Verbindung aufeinanderstossender Elemente erfolgt mittels Pfeilerkrallen sowie Gelenkplatte (siehe untenstehende Tabelle).

**3** Bei Verwendung von Wandelementen midi der Breite 100cm (Pfeilerelement) können Pfeiler mit einer Seitenlänge bis zu 75cm ausgeführt werden. Bei Verwendung von Wandelementen **midiplus** mit der Breite 90cm können Pfeiler mit einer Seitenlänge bis zu 65cm ausgeführt werden.

**4** Mögliche Pfeilergeometrien.

## PILLAR

**1** A column formwork can be realized by **midi** or **midiplus** panels assembled in a windmill-mode thanks to the multi-holed secondaries.

**2** The connection between the panels is realized using the **midi** or **midiplus** column coupler.

**3** Pillars up to 75 cm to be varied at 5 cm intervals can be shuttered with 100 cm **midi** panels (pillar panels) and with 90 cm **midiplus** pillar panels up to 65 cm.

**4** Columns dimensions.

## POTEAU

**1** Grâce aux filières de renfort à perçage multiple, il est possible d'assembler les panneaux **midi** ou **midiplus** en aile de moulin pour former des coffrages pour poteau.

**2** La liaison entre les panneaux extérieurs est assurée par des clés pour poteau **midi** ou **midiplus**.

**3** Avec des panneaux **midi** de 100 cm (panneau poteau) on peut couler des poteaux jusqu'à 75 cm avec des intervalles de 5 cm avec des panneaux **midiplus** de 90 cm on peut couler des poteaux jusqu'à 65 cm.

**4** Dimensions des poteaux.

## PILAR

**1** Por medio de los travesaños de refuerzo con agujeros múltiples se pueden ensamblar los paneles **midi** o **midiplus** de aspas de molino para realizar encofrados para pilar.

**2** La unión entre los paneles exteriores se logra por medio de llaves de pilar **midi** o **midiplus**.

**3** Con paneles **midi** de 100 cm (panel columna), se pueden hormigonar columnas hasta 75 cm con intervalos de 5 cm, con paneles **midiplus** de 90 cm, se pueden hormigonar columnas hasta de 65 cm.

**4** Dimensiones de los pilares.

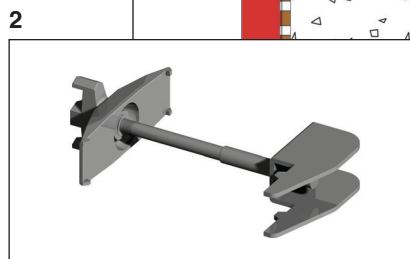
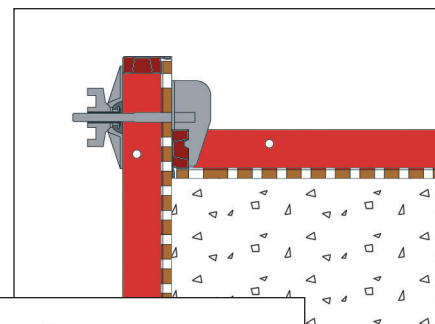



**midi**

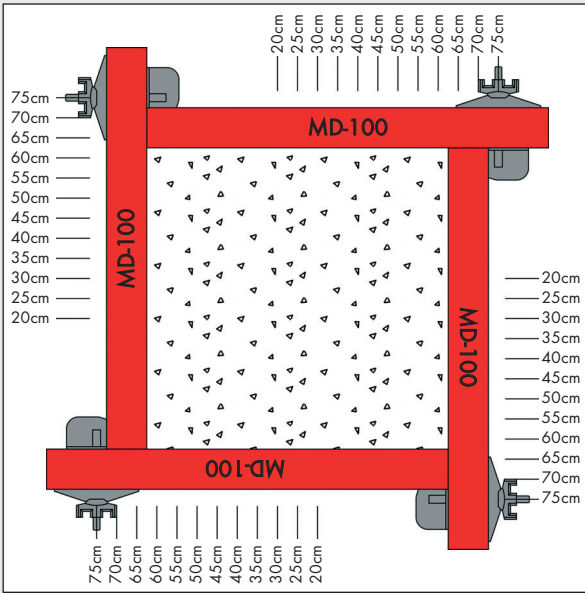

**midiplus**

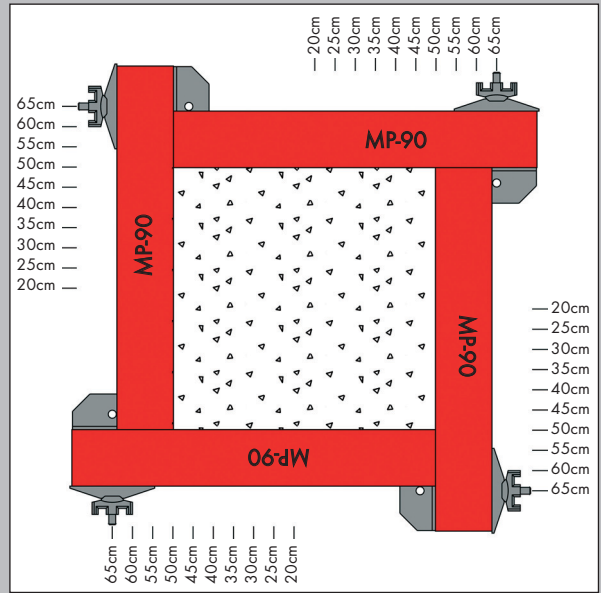

1

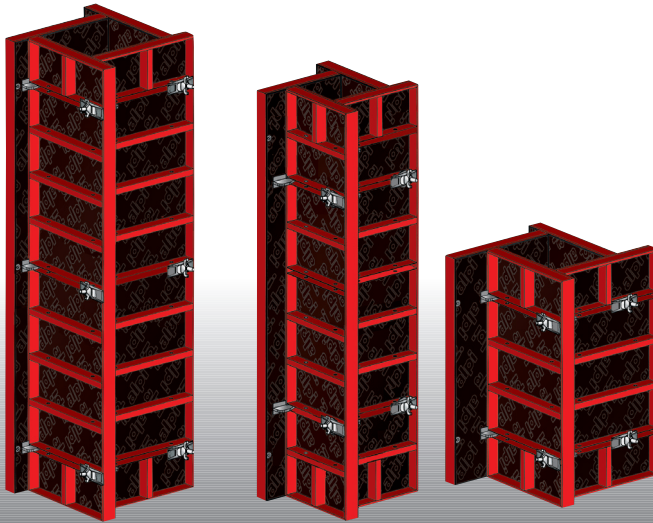

<b>H 300</b>	x 1 Pilastro =	12	Chiavi pilastro
	x 1 Pfeiler =		Pfeilerkrallen
	x 1 Column =		Column couplers
	x 1 Poteau =		Clés pour poteau
	x 1 Pilar =		Llaves de pilar

<b>H 270</b>	x 1 Pilastro =	8	Chiavi pilastro
	x 1 Pfeiler =		Pfeilerkrallen
	x 1 Column =		Column couplers
	x 1 Poteau =		Clés pour poteau
	x 1 Pilar =		Llaves de pilar

<b>H 150</b>	x 1 Pilastro =	8	Chiavi pilastro
	x 1 Pfeiler =		Pfeilerkrallen
	x 1 Column =		Column couplers
	x 1 Poteau =		Clés pour poteau
	x 1 Pilar =		Llaves de pilar

**Tabella pilastri  
Pfeiler-Tabelle  
Column table  
Tableau des poteaux  
Tabla de los pilares**

**midi** L100 = 25x25 -> 75x75

**midiplus** L90 = 25x25 -> 65x65

**midiplus** L60 = 25x25 -> 35x35

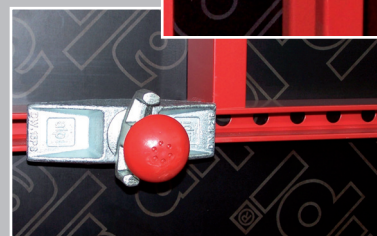

PILASTRO

PFEILER

PILAR

POTEAU

PILAR



## PARETI INCLINATE

**1** I profili di rinforzo e le boccole per il passaggio dei tiranti di collegamento permettono un'inclinazione dei pannelli impiegati in verticale fino a 4,5° sulla verticale.

L'impiego di pannelli **midi/midiplus** montati in orizzontale permette, grazie ai profili a foratura multipla, inclinazioni maggiori.

**2** In questo caso il tirante superiore della cassaforma passa fuori dal getto attraverso graffe di ancoraggio. Le placche snodate universali, adattandosi all'inclinazione del pannello, garantiscono la perfetta tenuta della cassaforma.

Altrove una piastra controplacca con un dado esagonale **3**, sostituisce le placche snodate **4**.



## GENEIGTE WÄNDE

**1** Durch die Geometrie des verstärkten C-Profiles (offene Querstrebe) der Wandelemente sowie der Spannerhülsen können bis zu 4,5°, bezogen auf die Vertikale, geneigte Wände ausgeführt werden.

Die vorgesehene Mehrfachbohrung ermöglicht weiterhin bei liegendem Einsatz der **midi/midiplus** Elemente grössere Neigungen.

**2** Vor allem bei liegendem Einsatz der Wandelemente ist es empfehlenswert den oberen Spannstab mit Hilfe der Spannerkralle aussenliegend einzubauen; hierbei wird dank der sich an die Neigung anpassenden Gelenkplatte eine optimale Verspannung der Schalung garantiert.

**3** Soll der untere Spannstab durch das eigentliche Spannloch des Elementes geführt werden, kann bei Platzmangel die Gegenplatte mit Sechskantmutter statt der Gelenkplatte **4** verwendet werden.



## INCLINED WALLS

**1** The multi-holed secondaries and the tapered holes of the plastic inserts permit vertical panels to be inclined 4,5° from a perfectly vertical position.

Use horizontal **midi/midiplus** panels and their multi-holed secondaries to make even greater inclinations.

**2** In this case the upper tie-rod could also pass out from the shuttering through a dry-tie bracket. The wingnut pivot plate, adapting to the inclination of the panel, ensures a perfect formwork seal.

In other situations a counterplate with hex nut **3** replaces the traditional wingnut **4**.



## VOILES INCLINÉS

**1** Les profilés de renfort et les douilles pour le passage des tiges de serrage permettent d'incliner les panneaux utilisés en position verticale jusqu'à 4,5° par rapport à la verticale.

L'emploi de panneaux **midi/midiplus** montés horizontalement permet grâce aux profilés à perçage multiple d'augmenter l'inclinaison des panneaux.

**2** Dans ce cas, l'entretoise supérieure du coffrage passe au travers d'étriers d'ancrage au dessus du béton. Les plaques articulées universelles permettent un serrage parfait du coffrage en s'adaptant à l'inclinaison du panneau.

Ailleurs, une contreplaque avec écrou hexagonal **3** remplace les plaques articulées **4**.



## MUROS INCLINADOS

**1** Los perfiles de refuerzo y los bujes para pasar los tirantes de unión permiten la inclinación de los paneles empleados en vertical hasta 4,5° sobre la vertical.

El empleo de paneles **midi/midiplus** montados en horizontal permite, gracias a los perfiles con agujeros múltiples, inclinaciones mayores.

**2** En este caso, el tirante superior del encofrado pasa a través de las grapas de anclaje fuera del encofrado. Las placas articuladas universales garantizan la unión perfecta del encofrado adaptándose a la inclinación del panel.

En otros sitios, una contraplaca con tuerca hexagonal **3** sustituye las placas articuladas **4**.

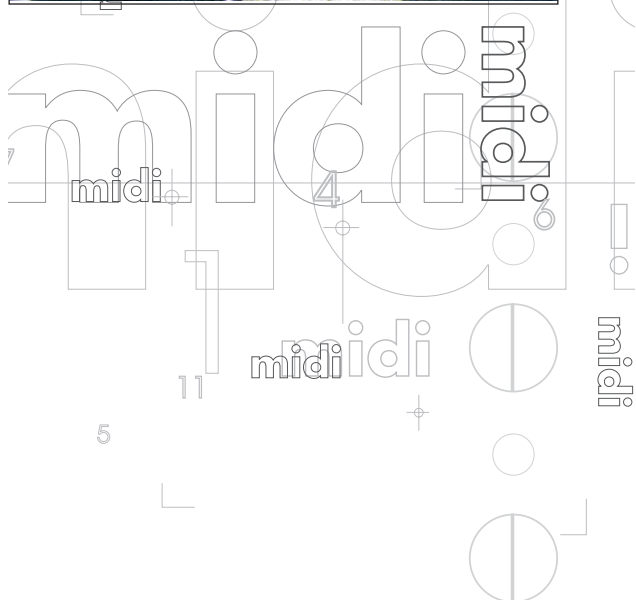

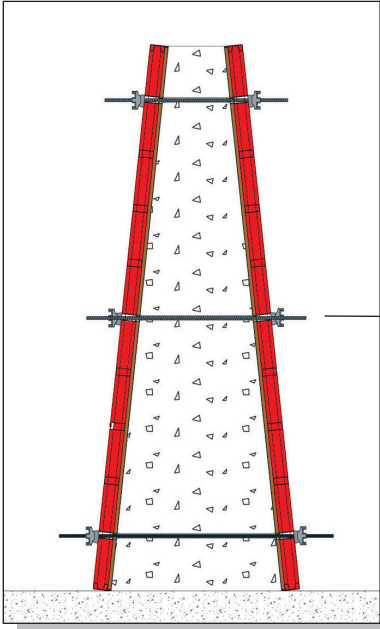

2

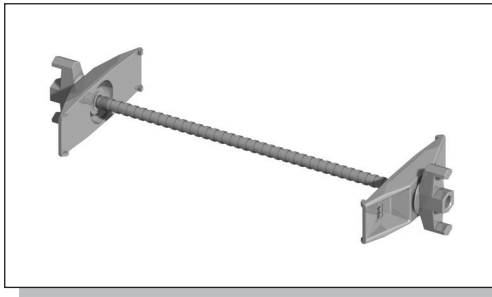

4

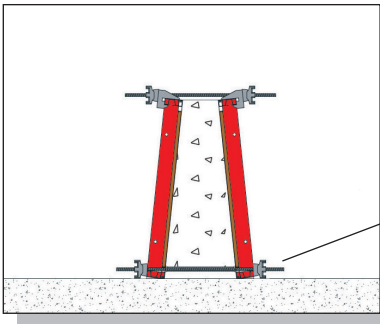
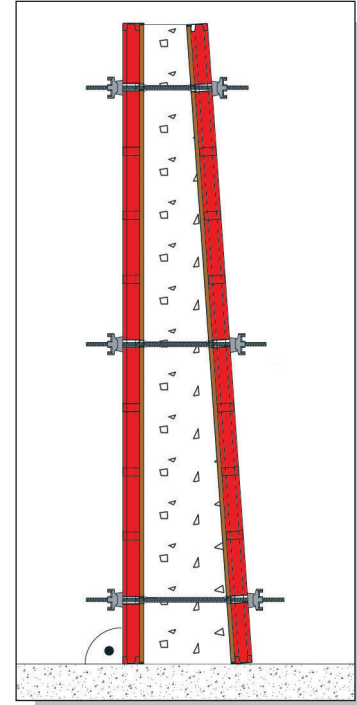
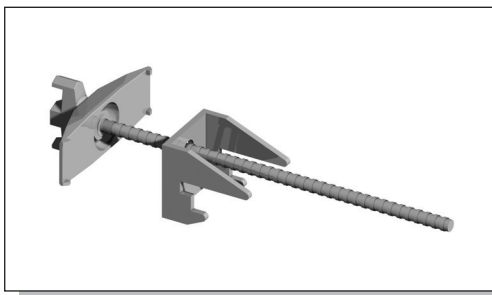

PARETI INCLINATE

GENEIGTE WÄNDE

INCLINED WALLS

VOILES INCLINÉS

MUROS INCLINADOS

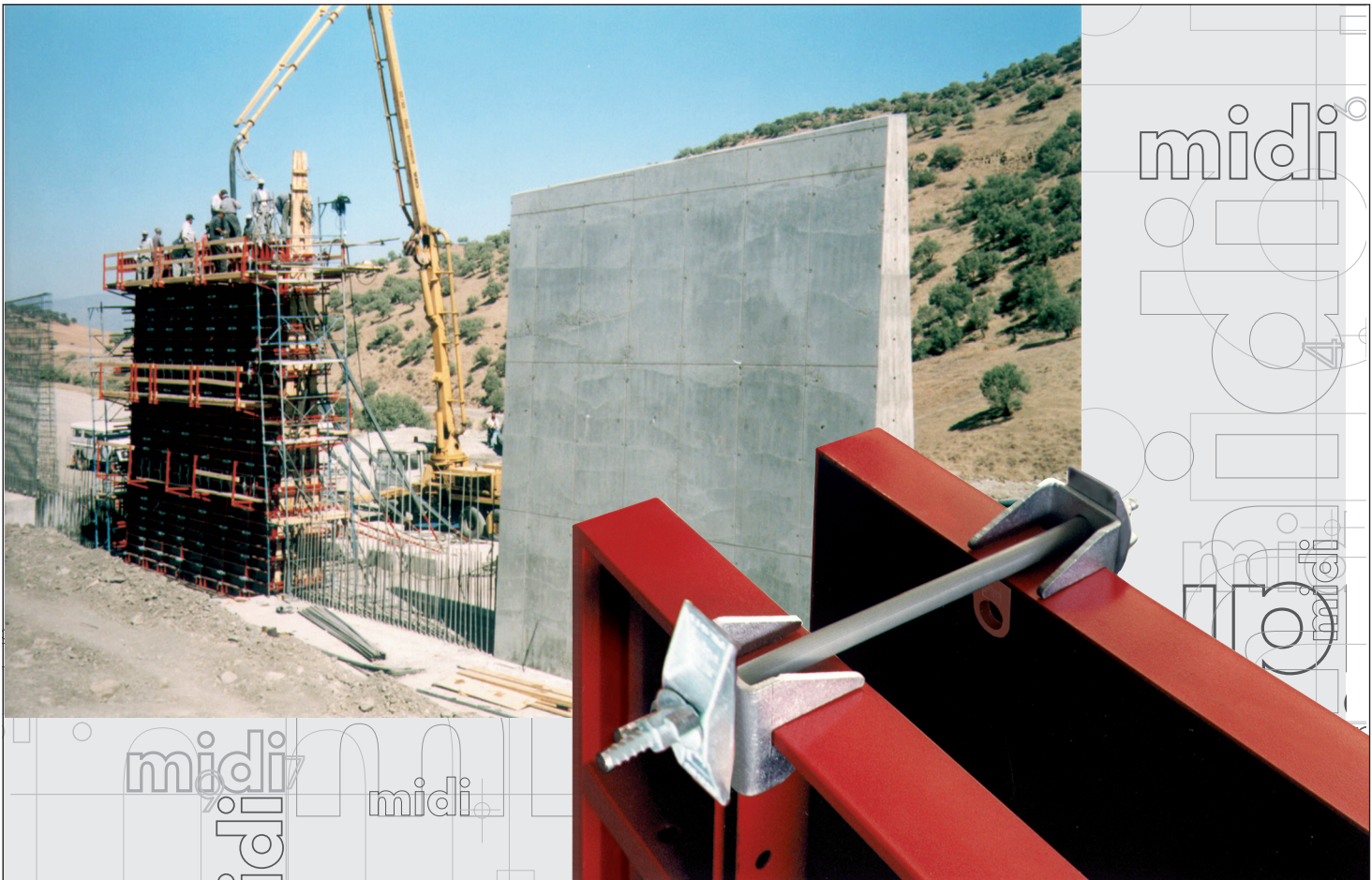





### SFALSAMENTO in ALTEZZA

**1** Il posizionamento libero delle morse su tutto il perimetro del telaio garantisce il serraggio e l'allineamento dei pannelli anche quando sono sfalsati. In questo caso il numero di tiranti e di morse utilizzati rimane invariato.

**2** L'Asta soprizzo **midi/midiplus** consente il montaggio di pannelli aggiuntivi per permettere al cassero di raggiungere esattamente l'altezza richiesta. Utilizzata fino ad un'altezza di 50 cm l'asta prevede il passaggio di un tirante supplementare in alto.

**3** L'impiego del sistema **meccano** permette di costruire pannelli di dimensioni e forma speciali, perfettamente abbinabili per allineamento e coplanarità con i pannelli standard **midiplus**. La giunzione tra i 2 sistemi è assicurata da allineatori diritti da 70 cm.

Riguardante il numero degli accessori utili vedi pag.116/126.



### AUFSTOCKUNGEN

**1** Auch bei höhenversetzter Anordnung benachbarter Wandelemente wird die fluchtende Ausrichtung aufgrund der möglichen Positionierung des Keilschlusses an jeder beliebigen Stelle des Randprofils garantiert. Die Anordnung der Spanner in gewohnter Art garantiert die volle Funktionsfähigkeit des Systems. Die erforderliche Anzahl von Keilschlössern und Spannern bleibt unverändert gegenüber der normalen Elementanordnung.

**2** Bei Verwendung der Aufstockschiene **midi/midiplus** kann die Rahmenschalung um weitere 50 cm aufgestockt werden. An der Oberkante ist ein weiterer Spannstab vorzusehen.

**3** Spezielle Geometrien können mit Hilfe des zum **midiplus** System kompatiblen meccano-Systems realisiert werden; hierbei dient der 70 cm lange Ausgleichsriegel als Verbindungselement zwischen den beiden Systemen.

Bzgl. der Anzahl der erforderlichen Zubehörteile siehe bitte S.116 bzw. S.126.



### HEIGHT STAGGERING

**1** Clamps are free to be placed along the entire edge of the frame. This ensures proper panel clamping and alignment even when panels are staggered. The number of tie-rods and clamps remains unchanged.

**2** The **midi/midiplus** extension bracket allows the mounting of additional panels to enable the formwork to exactly reach the required height. The extension bracket is used for heights up to 50 cm and an additional tie-rod passes through its upper part.

**3** Use the **meccano** system to create special sized and shaped panels that can combine perfectly, in alignment and coplanarity, with standard **midiplus** panels. 70 cm alignment walers create the joint between the 2 systems.

Refer to page 116/126 for the number of useful accessories.



### SURELEVATION EN HAUTEUR

**1** Le positionnement libre des pinces sur tout le périmètre du châssis garantit le serrage et l'alignement parfait des panneaux même lorsqu'ils sont décalés. Dans ce cas, le nombre d'entretoises et de pinces utilisées reste invarié.

**2** La tige surélévation **midi/midiplus** permet le montage de panneaux adjoints pour permettre au coffrage de rejoindre exactement l'hauteur demandée. Utilisée jusqu'à une hauteur de 50 cm la tige prévoit le passage d'un tirant supplémentaire en hauteur.

**3** L'emploi du système **meccano** permet de construire des panneaux aux dimensions et aux formes spéciales parfaitement coplanaires et alignés avec les panneaux **midiplus** standards. La liaison entre les 2 systèmes est assurée par des aligneurs droits de 70 cm.

Pour le nombre d'accessoires utiles, Cf. page 116/126.



### PROLONGACIÓN EN ALTURA

**1** El posicionamiento libre de las mordazas en todo el perímetro del armazón garantiza el apretamiento y la alineación de los paneles, aun cuando los mismos están superpuestos. En este caso, el número de tirantes y de mordazas permanece invariable.

**2** La varilla sobre-altura **midi/midiplus** permite el montaje de paneles adjuntivos para dar al encofrado la posibilidad de llegar a la altura richiesta. Utilizada hasta una altura de 50 cm la varilla permite el pasaje de un tirante suplementario en alto.

**3** El empleo del sistema **meccano** permite construir paneles de dimensiones y formas especiales, perfectamente alineados y coplanados con los paneles estándar **midiplus**. La unión entre los 2 sistemas está asegurada por los alineadores rectos de 70 cm.

Por lo que se refiere al número de accesorios, véase le pág. 116/126.



### 1 midi



### midiplus



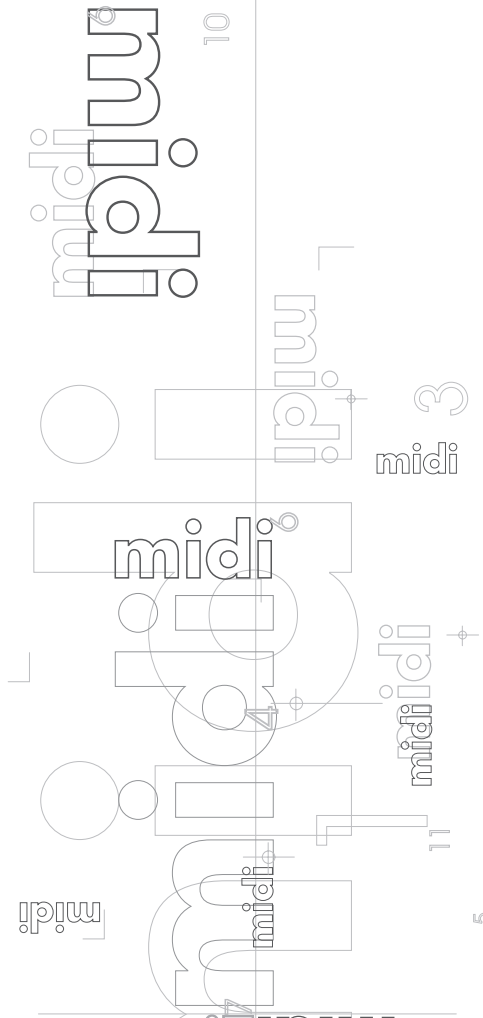
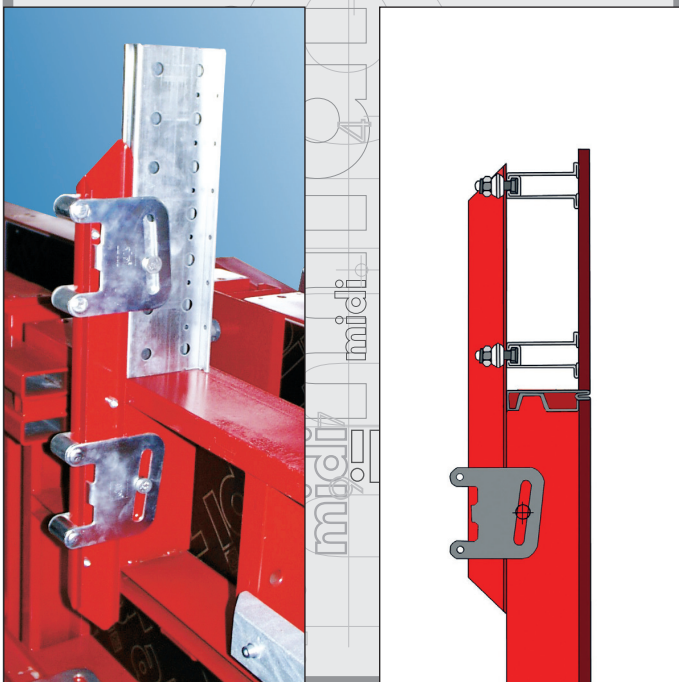
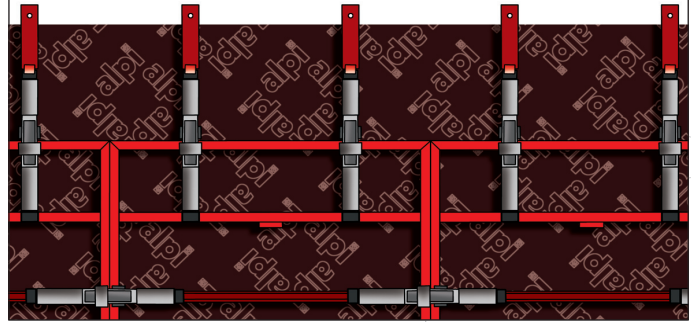
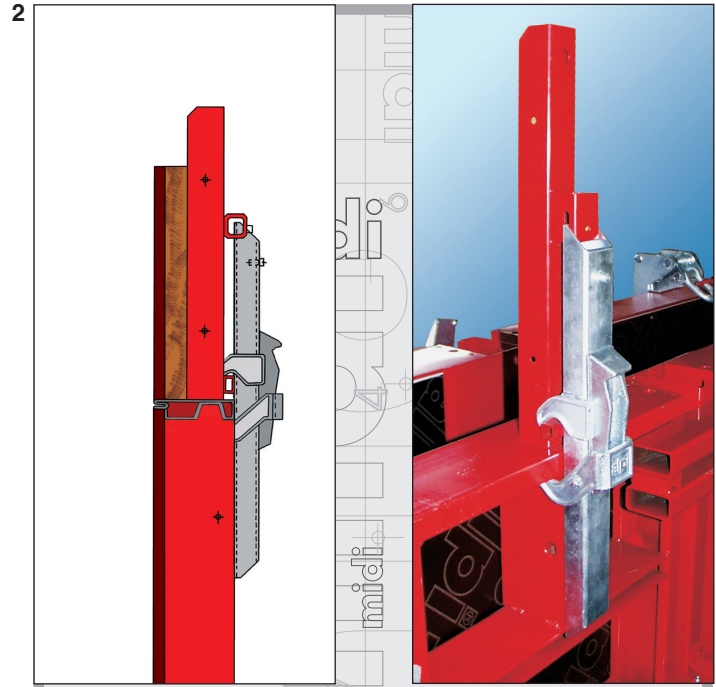
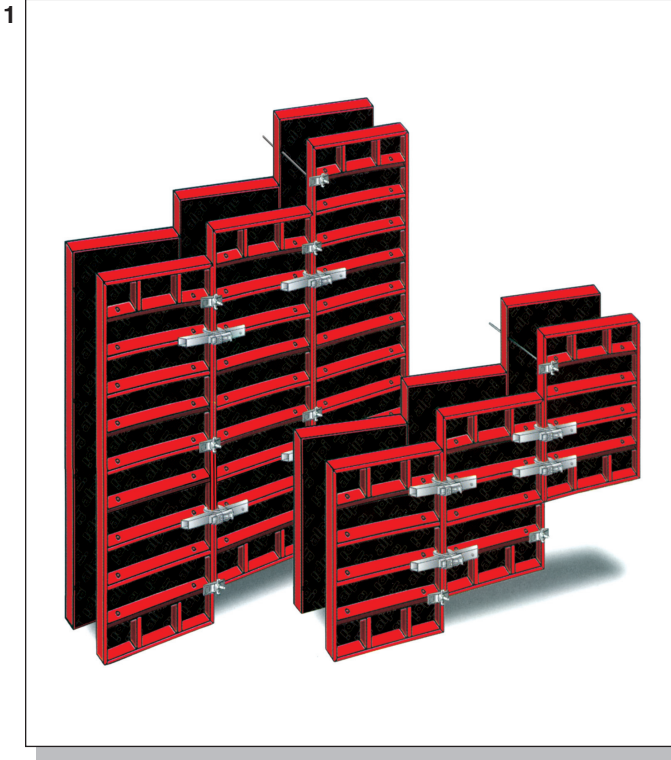

SFALSAMENTO in ALTEZZA

AUFSTOCKUNGEN

HEIGHT STAGGERING

SURELEVATION EN HAUTEUR

PROLONGACIÓN EN ALTURA



### TELAIO REGGISPINTA

1-2 I pannelli **midi/midiplus** sono utilizzati per il getto contro terra a monofaccia. In questo caso si adatta sul retro dei pannelli montati in posizione orizzontale dei telai di sostegno con altezza 3 mt o 5 mt.

3 Il fissaggio dei pannelli avviene mediante collegatori e placche snodate universali.

4 Vogliate consultare il ns. ufficio tecnico per la determinazione del tipo e del numero degli ancoraggi da prevedere al piede dei telai.



4

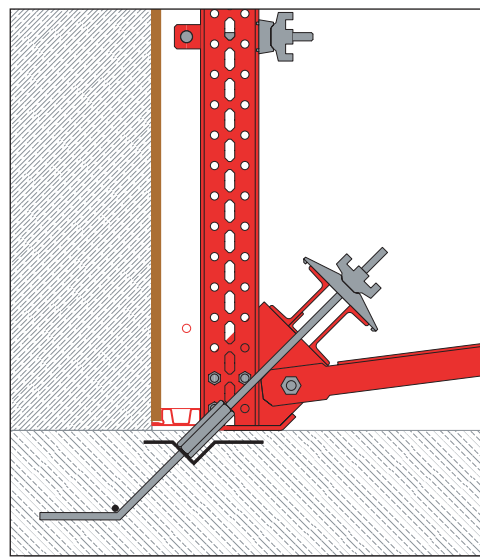

### STÜTZBOCKE

1-2 In Kombination mit dem **meccano**-Stützbock (Höhe 3 m und 5 m) können die **midi/midiplus**-Wandelemente als einhäuptige Schalung verwendet werden. Die Elemente werden in diesem Fall liegend, übereinander montiert eingesetzt.

3 Mit Hilfe von Verbindern und Gelenkplatten werden die Elemente mit den Stützböcken verbunden.

4 Bzgl. der Festlegung von Art und Anzahl der vorzusehenden Verankerungen wenden Sie sich bitte an unser Technisches Büro.

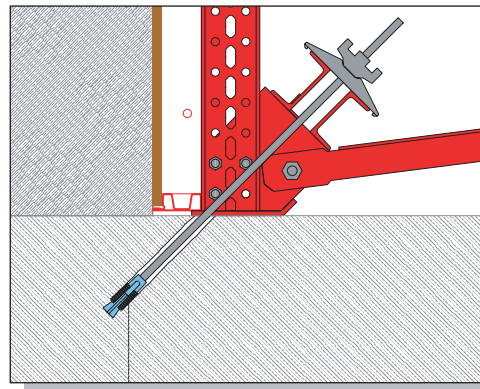

### STRONG BACK

1-2 **midi/midiplus** panels are also used for single-faced shutters. In this case 3 meter or 5 meter high strong backs are adapted at the rear of the horizontally assembled panels.

3 Use connectors and wingnut pivot plates to fasten the panels.

4 Consult our Engineering Department to calculate the number and type of anchors to install at the foot of the strong backs.

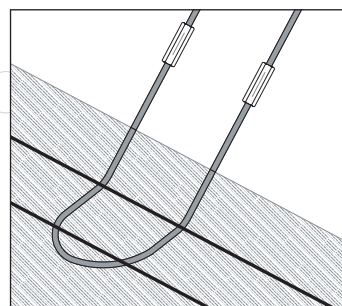

### FERME de REPRISE

1-2 Les panneaux **midi/midiplus** sont utilisés pour des coulages contre terre avec une seule face de coffrage. Dans ce cas, on adapte à l'arrière des panneaux montés horizontalement des châssis de reprise de 3 ou 5 m de hauteur.

3 La fixation des panneaux se fait à l'aide de liaisons panneau et de plaques articulées universelles.

4 Veuillez consulter notre bureau d'études pour la détermination du type et du nombre d'ancrages à prévoir au pied des châssis.



### ARMAZÓN PARA RESISTIR el EMPUJE

1-2 Los paneles **midi/midiplus** se emplean para vaciar contra el suelo con únicamente una cara de encofrado. En este caso, se adaptan en la parte de atrás de los paneles montados en posición horizontal unas armazones de soporte con altura de 3 metros o 5 metros.

3 La sujeción de los paneles se hace con las uniones y placas articuladas universales.

4 Sírvanse ponerse al habla con nuestro departamento técnico para establecer el tipo y el número de anclajes a preveer en la base de las armazones .





TSL-300

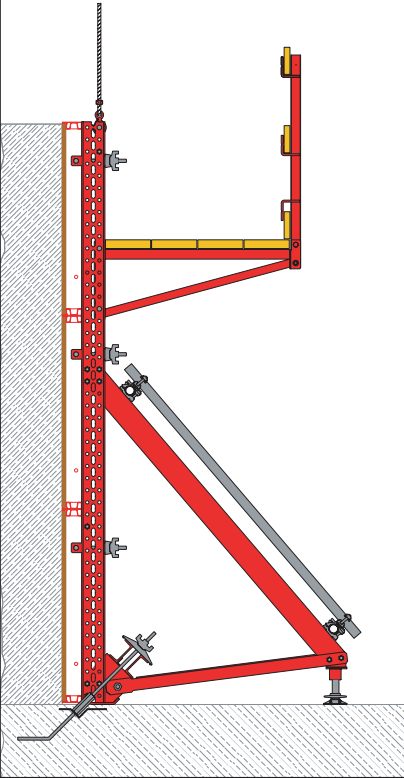

TELAIO REGGIPINTA

STÜTZBOCKE

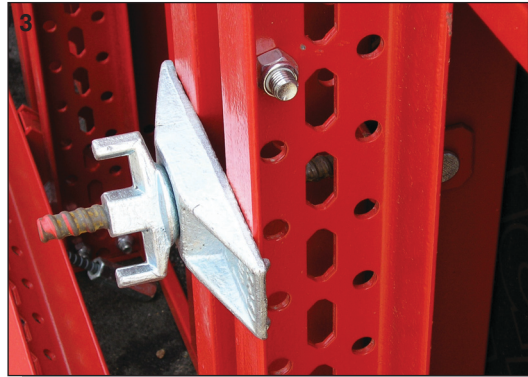
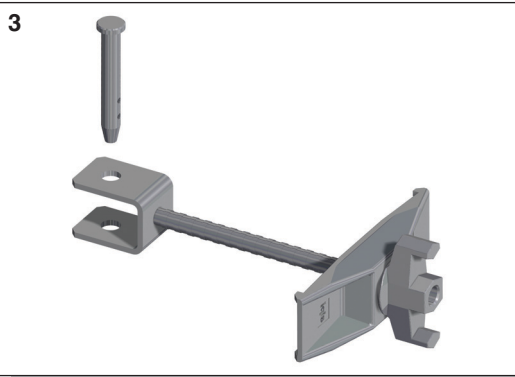

STRONG BACK



FERME de REPRISE

ARMAZÓN PARA RESISTIR el EMPUJE



### MENSOLE RAMPANTI

Si possono eseguire getti in elevazione con mensole e pianali rampanti **meccano** a sostegno dei pannelli **midi/miniplus**.

Consultare il ns. ufficio tecnico per la determinazione del numero e del tipo di ancoraggio dei rampanti.



### KLETTERKONSOLEN

In Kombination mit der **meccano**-Kletterkonsole können **midi/midiplus** Elemente auch als Kletterschalung eingesetzt werden.

Bzgl. der Festlegung von Art und Anzahl der vorzusehenden Verankerungen wenden Sie sich bitte an unser Technisches Büro.



### CLIMBING BRACKETS

Off-ground castings can be made with help of **meccano** climbing brackets and shaft-platforms supporting **midi** and **midiplus** panels.

Consult our Engineering Department to calculate the number and type of anchors for the climbing systems.



### CONSOLES GRIMPANTES

Les consoles et les platelages grimpants **meccano** permettent de soutenir les panneaux **midi/midiplus** pour les coulages en reprise.

Consultez notre bureau d'études pour la détermination du nombre et du type d'ancrage des platelages grimpants.



### MÉNSULAS RAMPANTES

Se puede hormigonar en altura con ménsulas y estantes rampantes **meccano** para soporte de los paneles **midi/midiplus**.

Sírvanse ponerse al habla con nuestro departamento técnico para establecer el número y el tipo de anclaje de los rampantes.



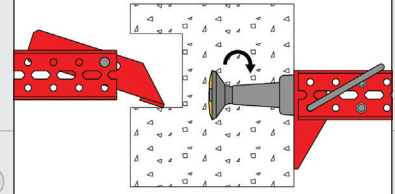
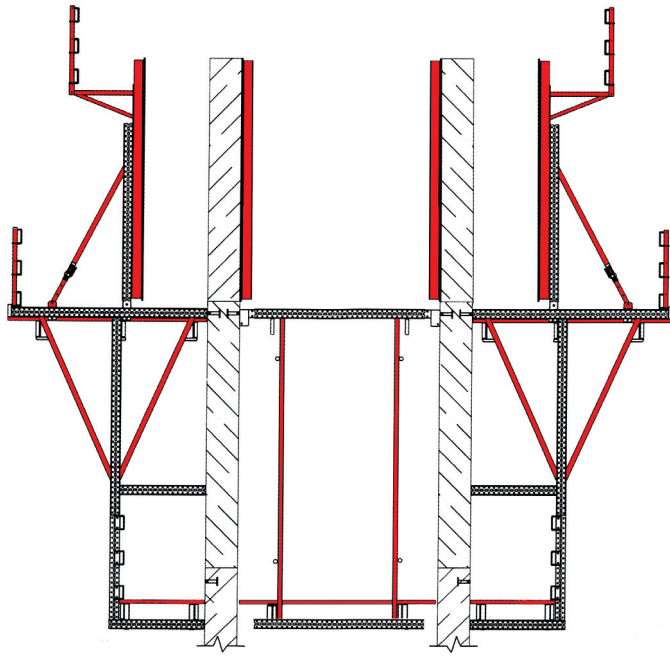

MENSOLE RAMPANTI

KLETTERKONSOLEN



CLIMBING BRACKETS



CONSOLES GRIMPANTES

MÉNULAS RAMPANTES



### GANCIO di SOLLEVAMENTO

**1** I ganci di sollevamento **midi** o **midi-plus** a bloccaggio automatico consentono il sollevamento con la gru di grandi elementi di cassaforma costituiti da più pannelli.

**2** I ganci di sollevamento, utilizzati sempre in coppia devono essere imperativamente posizionati a cavallo di una traversa di rinforzo dove saranno bloccati automaticamente dalle molle.

**3** Per lo sbloccaggio del gancio basta fare leva sulla barra posteriore della molla per liberare il gancio.

Peso: 7 kg  
Portata: 1.500 kg

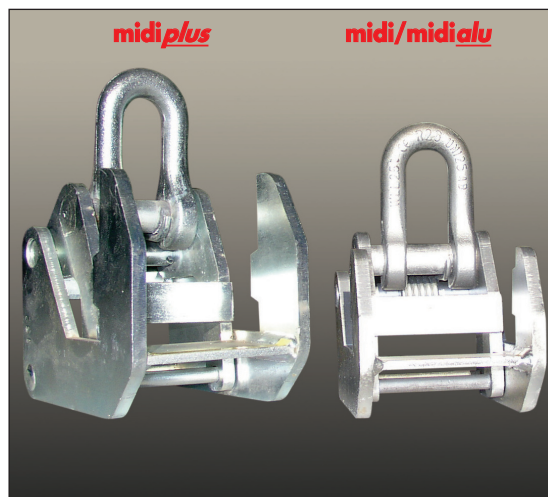

### KRANHAKEN

**1** Mit Hilfe des einhändig bedienbaren und sich automatisch blockierenden **midi** oder **midiplus** Kranhakens können großflächige aus mehreren Elementen bestehende Schaleinheiten gehoben werden.

**2** Je anzuhebende Einheit sind immer zwei Kranhaken in gezeigter Art zu verwenden; die Kranhaken müssen hierbei immer jeweils eine Verstärkungsstrebe umfassen. Durch eine integrierte Feder wird der bewegliche Teil des Kranhakens gegen das Randprofil

des Wandelementes gedrückt und somit fixiert.

**3** Das Anheben der hinteren Querstange des Kranhakens bewirkt das Lösen desselben vom Element.

Gewicht: 7 kg  
Tragfähigkeit: 1500 kg



### CRANE HOOK

**1** **midi** or **midiplus** self-locking crane hooks permit cranes to lift large forms composed of multiple panels.

**2** Crane hooks are always used in pairs and must necessarily be placed each embracing a stiffener.

**3** To release the hook just pull the rear bar of the spring to free the hook.

Weight: 7 kg  
SWL: 1500 kg



### ANNEAU de LEVAGE

**1** Les anneau de levage **midi** ou **midi-plus** au blocage automatique permettent la manutention à la grue de grands éléments de coffrage constitués par plusieurs panneaux.

**2** Les anneau de levage utilisés toujours par 2 doivent obligatoirement être placés à cheval d'un longeron où ils seront bloqués automatiquement par les ressorts.

**3** Pour le déblocage de l'anneau, il suffit de faire pression sur la barre arrière du ressort pour dégager l'anneau.

Poids d'un anneau de levage: 7 kg  
Charge utile maximale :1.500 kg



### GANCHO de ELEVACIÓN

**1** Los ganchos de elevación **midi** o **midiplus** de bloqueo automático permiten levantar a la grúa grandes elementos de encofrado constituidos por varios paneles.

**2** Los ganchos de elevación, utilizándose siempre dos, tienen que estar obligatoriamente colocados cada uno a caballo de un travesaño de refuerzo donde serán bloqueados automáticamente por los resortes.

**3** Para desbloquear el gancho, basta con presionar en la barra trasera del resorte para liberar el gancho.

Peso de un gancho de elevación: 7 Kg  
Carga máxima: 1.500 kg



max 2x1500 kg

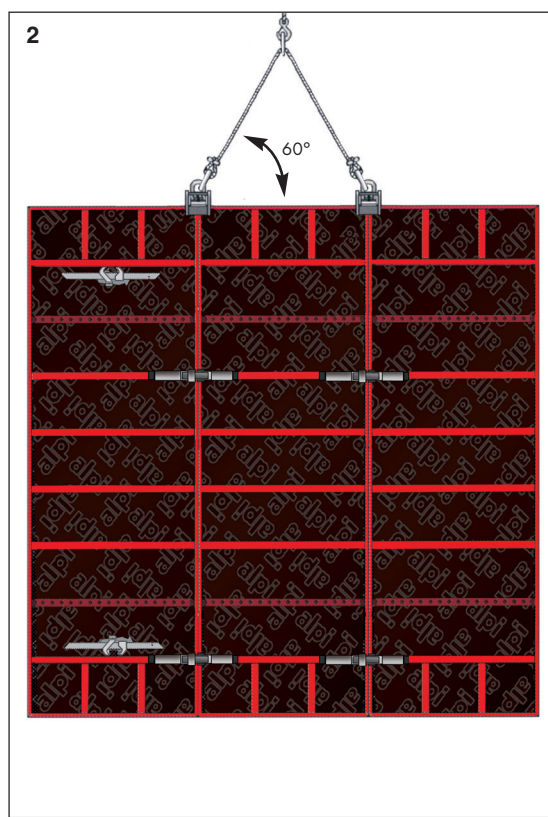

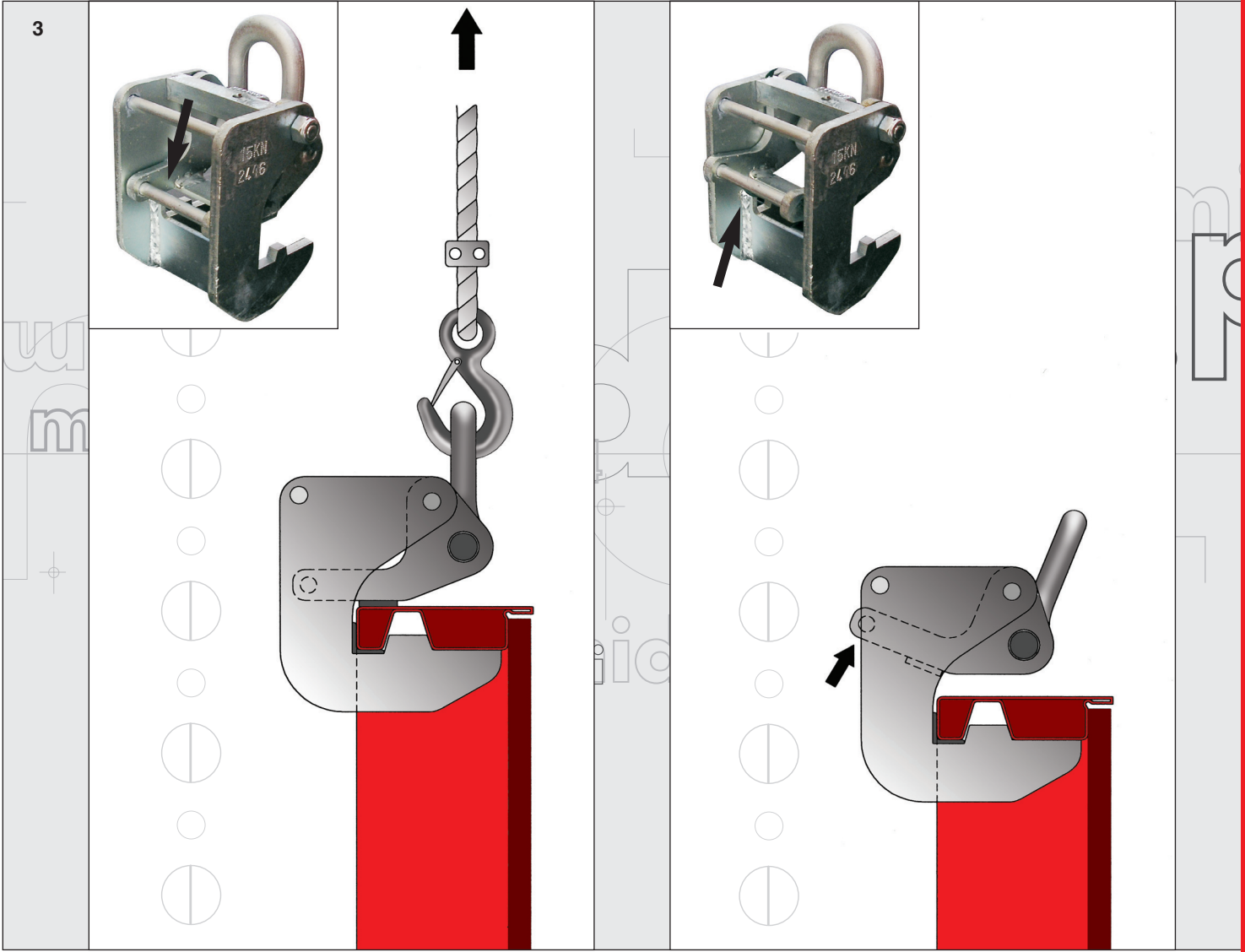

GANCIO di SOLLEVAMENTO

KRANHAKEN

CRANE HOOK

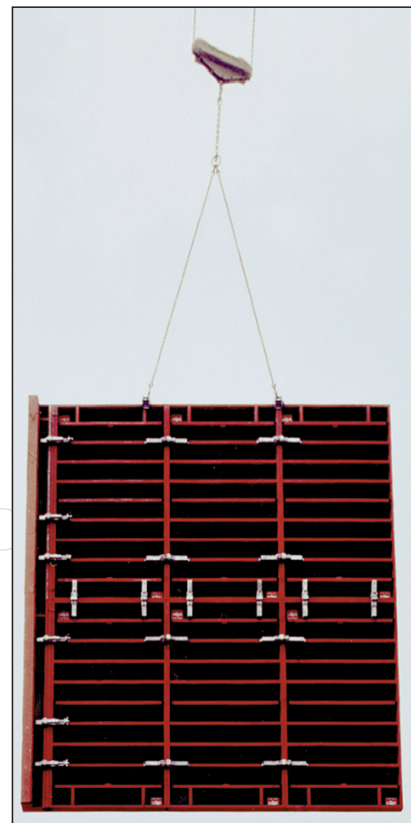

ANNEAU de LEVAGE

GANCIO de ELEVACIÓN





### STOCCAGGIO

**1** Profili di movimentazione contenitori. I supporti di movimentazione permettono lo stoccaggio, l'accatastamento, la movimentazione e il trasporto sicuro dei pannelli **midi/midiplus**.

**4** Profili servono per il trasporto di 10/7 pannelli **midi/midiplus**.

### TRASPORTO

**2** I contenitori per gli accessori permettono di raggruppare e trasportare tutti gli accessori eliminando inutili movimentazioni e smarrimenti tra un utilizzo e l'altro.

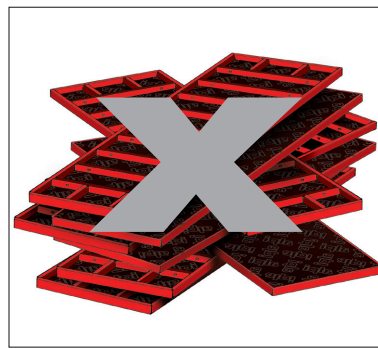

### LAGERUNG

**1** Die Transportwinkel ermöglichen ein sicheres Transportieren, Handhaben, Stapeln sowie eine sichere Lagerung der **midi/midiplus** Elemente.

Die Transportwinkel werden in den Ecken der Elemente angeordnet; mit einem Satz (4 Stück) können bis zu 10/7 **midi/midiplus** Elemente transportiert werden.

### TRANSPORT

**2** Die Zubehörbehälter ermöglichen eine übersichtliche Lagerung von Kleinteilen sowie deren sicheren Transport; hierdurch werden unnötige zusätzliche Transportwege vermieden sowie die Anzahl der Verluste von Kleinteilen auf ein Minimum reduziert.

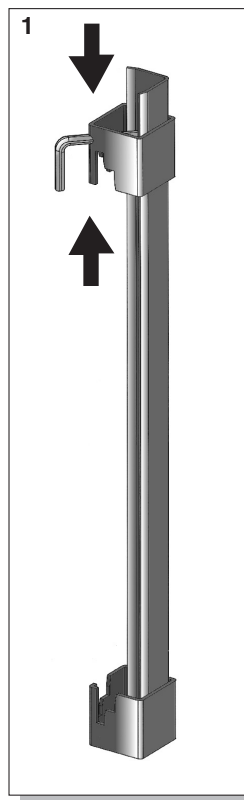

### STORAGE

**1** The Transport angle permits safe storage, stacking, handling and transportation of **midi/midiplus** panels.

For the transport of 10 **midi** or 7 **midiplus** panels are 4 angles needed.

### TRANSPORTATION

**2** Containers for accessories gather together and carry all accessories, eliminating losses and unnecessary handling between one job and the next.



### STOCKAGE

**1** Profils de manutention - casiers de rangement. Les cornières de manutention permettent le stockage, l'empilage, la manutention et le transport en toute sécurité des panneaux **midi/midiplus**.

**4** Profils servent au transport de 10/7 panneaux **midi/midiplus**.

### TRANSPORT

**2** Les casiers de rangement pour accessoires servent à regrouper et à transporter tous les accessoires en éliminant d'inutiles manutentions et pertes entre une utilisation et l'autre.

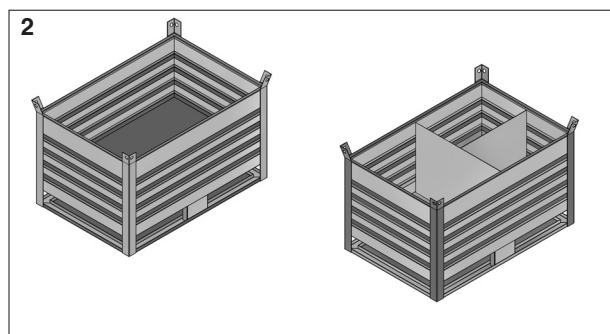

### ALMACENAMIENTO

**1** Perfiles de desplazamiento de los contenedores. Los soportes de desplazamiento permiten el almacenaje, el apilamiento, el desplazamiento y el transporte seguros de los paneles **midi/midiplus**.

**4** Perfiles sirven para transportar 10/7 paneles **midi/midiplus**.

### TRANSPORTE

**2** Las cajas de accesorios permiten agrupar y transportar todos los accesorios eliminando movimientos inútiles así como pérdidas entre un empleo y otro.

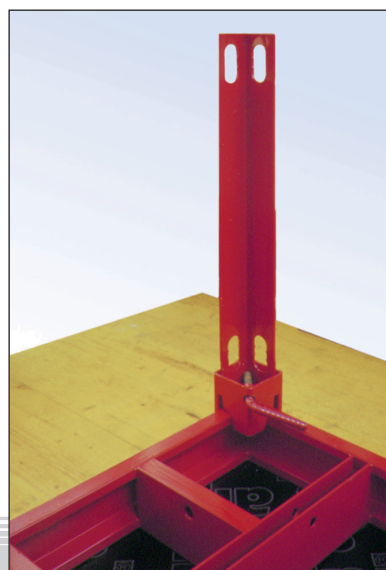



STOCCAGGIO e TRASPORTO

LAGERUNG und TRANSPORT

STORAGE and TRANSPORTATION

STOCKAGE et TRANSPORT

ALMACENAMIENTO y TRANSPORTE



**Tabella di compensazione  
 Tabelle Zubehöerteile  
 Compensation table  
 Tableau de compensation  
 Tabla de compensación**

medi/midialu																														
<b>H 300</b>	Pannello Wandelement Panel Pannau Panel	Anglio interno Internal corner Inneck Internal hinge Anglio interno	Anglio esterno External corner Außenek External hinge Anglio esterno	Anglio esterno snodato External hinge Außenek, beweglich Anglio exterior articulado	Asta di compenso Ausgleichsstab Filler profile Tige de compensation Varilla de compensación	Compensu in legno Holz Ausgleich Timber filler Compensador de madera	Compensu in legno Holz Ausgleich Timber filler Compensador de madera	Compensu di disarmo Ausschlag Ausgleich Striking filler Compensador de desarme	Anglio disarmo Ausschläcke Striking Corner Anglie de décofrage Anglio de desarme	Asta di compenso Ausgleichsstab Filler profile Tige de compensation Varilla de compensación	Compensu di disarmo Ausschlag Ausgleich Striking filler Compensador de desarme	Anglio esterno snodato External hinge Außenek, beweglich Anglio exterior articulado	Lamiera di compenso Ausgleichsblech Filler plate Tôle de compensation Lámina de compensación	Pannello Wandelement Panel Pannau Panel	Tiranti DW15 Spannstäbe DW15 Tie-rods DW15 Tirants DW15 Tirantes DW15															
																Morsa Keilschloß Clamp Pince Mordaza	Morsa a vite MP/MD-30/15 Schraubzwinge MP/MD-30/15 Adjustable clamp MP/MD-30/15 Pince à vis MP/MD-30/15 Mordaza de tornillo MP/MD-30/15	Anglio interno snodato External hinge Außenek, beweglich Anglio interno articulado	Anglio esterno con pannelli External corner with panels Außenek mit Wandelement Anglie extérieur avec panneaux Anglio exterior con paneles	Compensu in legno Holz Ausgleich Timber filler Compensador de madera	Compensu in legno Holz Ausgleich Timber filler Compensador de madera	Compensu di disarmo Ausschlag Ausgleich Striking filler Compensador de desarme	Compensu di disarmo Ausschlag Ausgleich Striking filler Compensador de desarme	Anglio disarmo Ausschläcke Striking Corner Anglie de décofrage Anglio de desarme	Asta di compenso Ausgleichsstab Filler profile Tige de compensation Varilla de compensación	Compensu di disarmo Ausschlag Ausgleich Striking filler Compensador de desarme	Anglio esterno snodato External hinge Außenek, beweglich Anglio exterior articulado	Lamiera di compenso Ausgleichsblech Filler plate Tôle de compensation Lámina de compensación	Pannello Wandelement Panel Pannau Panel	Tiranti DW15 Spannstäbe DW15 Tie-rods DW15 Tirants DW15 Tirantes DW15
Morsa a vite MP/MD-30/15 Schraubzwinge MP/MD-30/15 Adjustable clamp MP/MD-30/15 Pince à vis MP/MD-30/15 Mordaza de tornillo MP/MD-30/15	Anglio interno snodato External hinge Außenek, beweglich Anglio interno articulado	Anglio esterno con pannelli External corner with panels Außenek mit Wandelement Anglie extérieur avec panneaux Anglio exterior con paneles	Compensu in legno Holz Ausgleich Timber filler Compensador de madera	Compensu in legno Holz Ausgleich Timber filler Compensador de madera	Compensu di disarmo Ausschlag Ausgleich Striking filler Compensador de desarme	Compensu di disarmo Ausschlag Ausgleich Striking filler Compensador de desarme	Anglio disarmo Ausschläcke Striking Corner Anglie de décofrage Anglio de desarme	Asta di compenso Ausgleichsstab Filler profile Tige de compensation Varilla de compensación	Compensu di disarmo Ausschlag Ausgleich Striking filler Compensador de desarme	Anglio esterno snodato External hinge Außenek, beweglich Anglio exterior articulado	Lamiera di compenso Ausgleichsblech Filler plate Tôle de compensation Lámina de compensación	Pannello Wandelement Panel Pannau Panel	Tiranti DW15 Spannstäbe DW15 Tie-rods DW15 Tirants DW15 Tirantes DW15																	
														Morsa a vite MP/MD-30/15 Schraubzwinge MP/MD-30/15 Adjustable clamp MP/MD-30/15 Pince à vis MP/MD-30/15 Mordaza de tornillo MP/MD-30/15	Anglio interno snodato External hinge Außenek, beweglich Anglio interno articulado	Anglio esterno con pannelli External corner with panels Außenek mit Wandelement Anglie extérieur avec panneaux Anglio exterior con paneles	Compensu in legno Holz Ausgleich Timber filler Compensador de madera	Compensu in legno Holz Ausgleich Timber filler Compensador de madera	Compensu di disarmo Ausschlag Ausgleich Striking filler Compensador de desarme	Compensu di disarmo Ausschlag Ausgleich Striking filler Compensador de desarme	Anglio disarmo Ausschläcke Striking Corner Anglie de décofrage Anglio de desarme	Asta di compenso Ausgleichsstab Filler profile Tige de compensation Varilla de compensación	Compensu di disarmo Ausschlag Ausgleich Striking filler Compensador de desarme	Anglio esterno snodato External hinge Außenek, beweglich Anglio exterior articulado	Lamiera di compenso Ausgleichsblech Filler plate Tôle de compensation Lámina de compensación	Pannello Wandelement Panel Pannau Panel	Tiranti DW15 Spannstäbe DW15 Tie-rods DW15 Tirants DW15 Tirantes DW15			



**Velocità di getto:  
Betongeschwindigkeit:  
Casting speed:  
Vitesse de bétonnage:  
Velocidad de hormigonado:**

*Alpi declina ogni responsabilità per la velocità di getto scorretto.  
Alpi übernimmt keine Haftung für falsche Betoniergeschwindigkeiten.  
Alpi declines all liability for non-compliance with the casting speed.  
Alpi décline toute responsabilité en cas de non-respect de la vitesse de bétonnage.  
La empresa Alpi rehusa cualquier responsabilidad en caso de velocidad de hormigonado incorrecta.*

Misura di compressione secondo Walz.  
Verdichtungsmaß nach Walz.  
Compression measure according to Walz.  
Mesure de compression selon Walz.  
Medida de compresión según Walz.

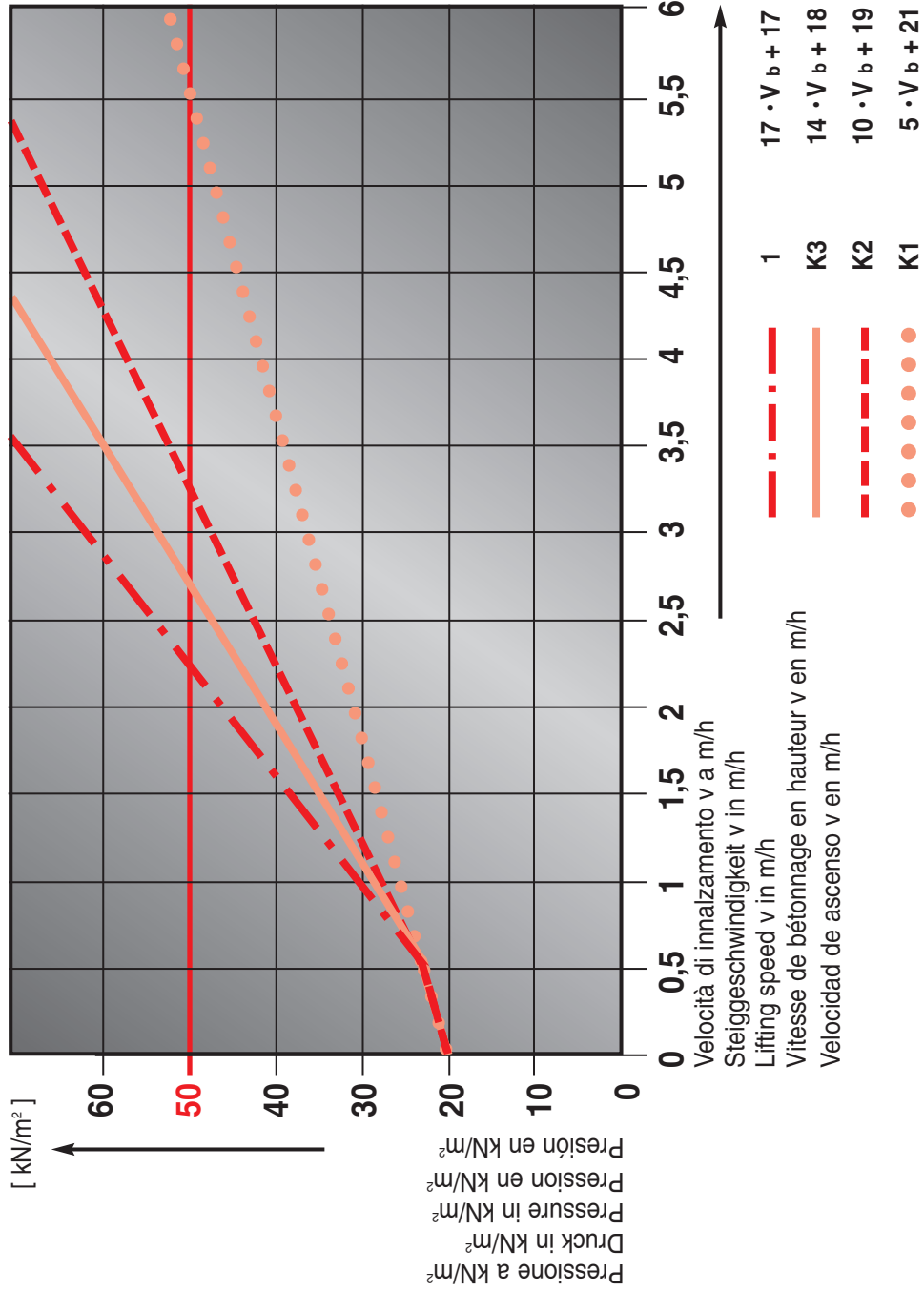

- 1 Calcestruzzo molle
- Fließbeton
- Soft concrete
- Béton fluide
- Hormigón fluido

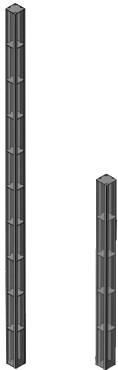
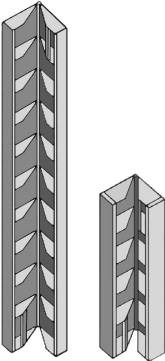
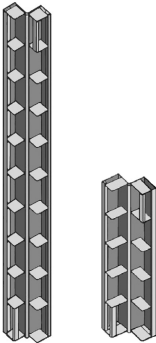
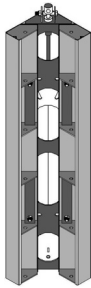
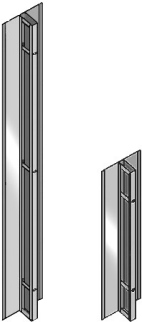

	ART.	Comp.	COD	cm	Kg		
	<b>midi</b> <b>300</b>		MD	300/200	220,2	Pannello	
			MD	300/100	113,2	Wandelement	
			MD	300/100*	117,6	Panel	
			MD	300/75	91,0	Panneau	
			MD	300/50	68,8	Panel	
			MD	300/25	47,6		
						<ul style="list-style-type: none"> <li>*Profili a foratura multipla</li> <li>*Mehrfachbohrungsprofile</li> <li>*Multiple perforated sections</li> <li>*Profils multiperçage</li> <li>*Perfiles con agujeros múltiples</li> </ul>	
	<b>midi</b> <b>150</b>		MD	150/100	62,8	Pannello	
			MD	150/75	49,7	Wandelement	
			MD	150/50	36,6	Panel	
			MD	150/25	25,0	Panneau	
						Panel	
	<b>midi</b> <i>alu</i> <b>300</b>		MA	300/100	65,1	Pannello	
			MA	300/75	51,8	Wandelement	
			MA	300/50	38,6	Panel	
			MA	300/25	26,0	Panneau	
						Panel	
	<b>midi</b> <i>alu</i> <b>150</b>		MA	150/100	35,1	Pannello	
			MA	150/75	27,6	Wandelement	
			MA	150/50	20,2	Panel	
			MA	150/25	13,5	Panneau	
						Panel	
			MD-AI	300/30	89,8	Angolo interno 90°	
			MD-AI	150/30	45,8	90°-Inneck	
						90° internal corner	
						Angle intérieur 90°	
						Angulo interior 90°	

	ART.	Comp.	COD	cm	Kg	
	560 800 560 820		MD-AE MD-AE	300 150	27,1 13,7	Angolo esterno 90° 90°-Außeneck 90° external corner Angle extérieur 90° Angulo exterior 90°
	560 700 560 720		MD-AIS MD-AIS	300/30 150/30	85,9 44,4	Angolo interno snodato 60-180° 60-180°-Inneneck, beweglich 60-180° internal hinge corner Angle intérieur articulé 60-180° Angulo interior articulado 60-180°
	560 900 560 920		MD-AEs MD-AEs	300 150	55,8 28,2	Angolo esterno snodato 0°-180° 0°-180°-Außeneck, beweglich 0°-180° external hinge corner Angle extérieur articulé 0°-180° Angulo exterior articulado 0°-180°
	560 750 560 760			300/30 150/30	129,9 69,7	Angolo Disarmo Ausschalecke Dismantling Corner Angle de Decoffrage Angulo Desarmo
	560 200 560 220		MD-LC MD-LC	300/30 150/30	42,5 21,7	Lamiera di compenso 5-30 cm Ausgleichsblech 5-30 cm Filler plate 5-30 cm Tôle de compensation 5-30 cm Lámina de compensación 5-30 cm



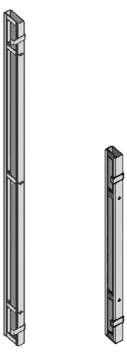
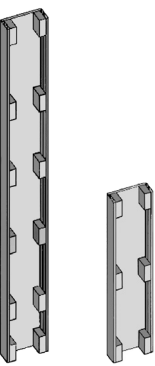
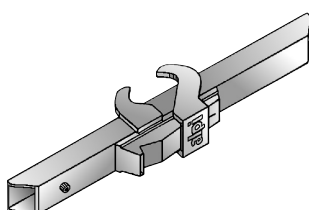
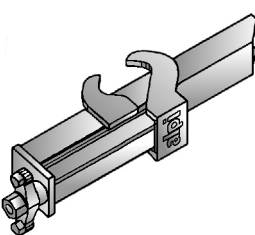
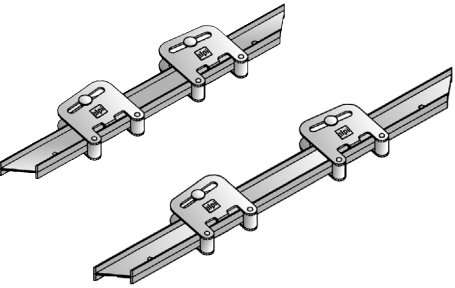

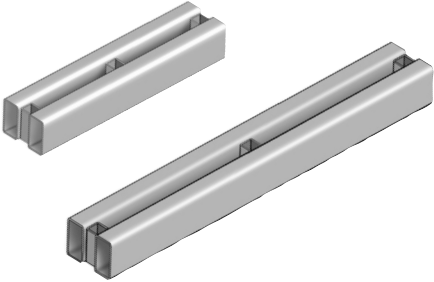
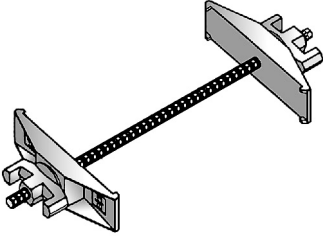
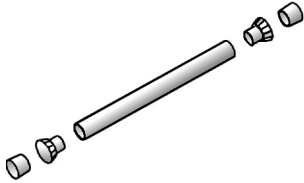
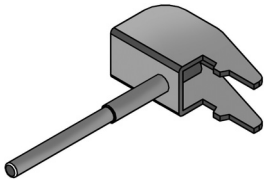
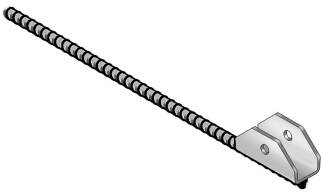
	ART.	Comp.	COD	cm	Kg	
	560 400 560 420		MD-AC MD-AC	300/05 150/05	14,7 8,8	Asta di compenso Ausgleichsstab Filler profile Tige de compensation Varilla de compensación
	560 560 560 580		MD-PC MD-PC	PC-300 PC-150	29,8 14,9	Profilo di compenso Ausgleichsprofil Compensation profile Profilé de compensation Perfil de compensación
	580 531		MP/MD-60	60	5,3	Morsa diritta <i>midi/midiplus</i> <i>Gerades midi/midiplus-</i> <i>Keilschloß</i> <i>midi/midiplus clamp</i> <i>Pince droite midi/midiplus</i> <i>Mordaza recta midi/midiplus</i>
	580 536		MP/MD-15	0-15	4,7	Morsa a vite <i>midi/midiplus</i> <i>midi/midiplus-Schraubzwinge</i> <i>midi/midiplus adjustable</i> <i>clamp</i> <i>Pince à vis midi/midiplus</i> <i>Mordaza de tornillo</i> <i>midi/midiplus</i>
	580 270 580 275		AD-70 AD-100	70 100	6,7 7,9	Allineatore diritto Ausgleichsriegel Alignment waler Aligneur droit Alineador recto

	ART.	Comp.	COD	cm	Kg	
	580 210		TC/FG-50	50	7,6	Traversino di compenso
	581 019		TC/FG-80	80	11,9	Spannerbrücke Joint plate anchor sleeper Aligneur de compensation Alineador de compensación
	800 030		DW-15	d= 1,5 85	1,2	Tirante Spannstab Tie-rod Tirant Tirante
	800 500		TI	15	1,8	Placca snodata Gelenkplatte Anchor plate Plaque articulée Placa articulada
	840 000		PV	d= 2 20	0,3	Tubo distanziatore PVC PVC-Distanzrohr PVC distance tube Tube d'écartement en PVC Tubo distancidor PVC
	840 200		PV	d= 2	0,00	Rosetta in PVC PVC-Konus PVC cone Embout en PVC Arandela en PVC
	840 300		PV	d= 2	0,00	Tappo in PVC per distanz. PVC-Stopfen für Distanzrohr PVC plug for distance tube Bouchon tube d'écartement en PVC Tapón en PVC para distanc.
	580 517		CM	28	2,1	Chiave pilastro <i>mediplus</i> Pfeilerkralle <i>medi</i> <i>mediplus</i> pillar coupling Clé pour poteau <i>mediplus</i> Llave de pilar <i>mediplus</i>
	581 015		CM	60	1,6	Graffa ferma getto Stirnabschalungskralle stop end Arrêt béton Grapa de cierre lateral para hormigonado



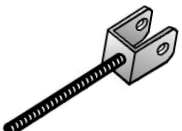
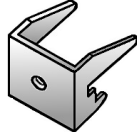
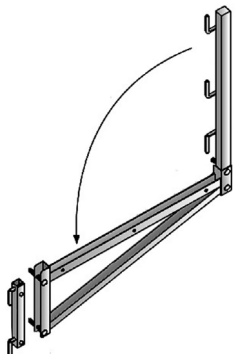
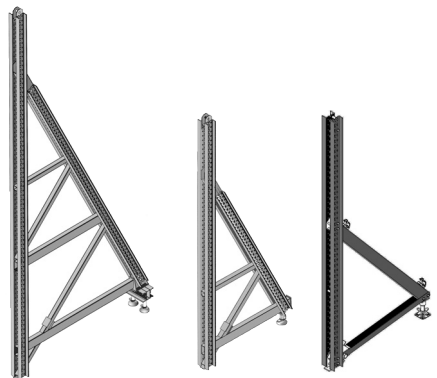
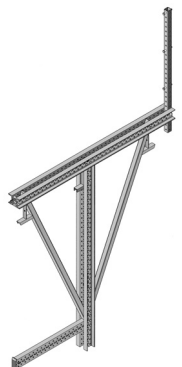

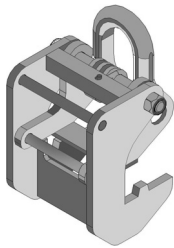
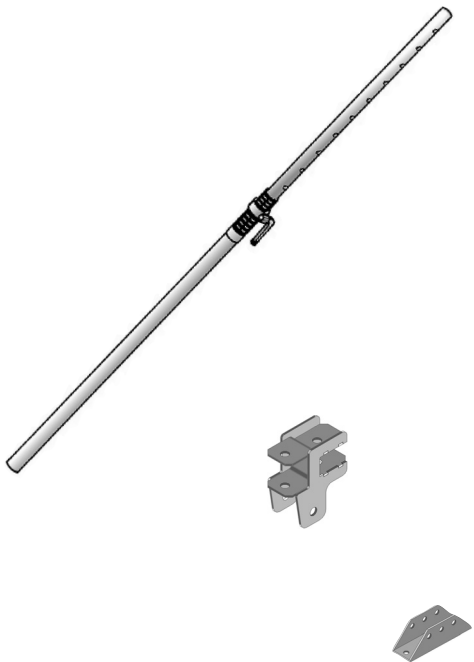

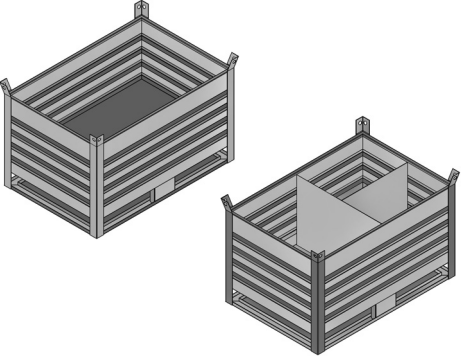

	ART.	Comp.	COD	cm	Kg	
	630 570		CM	22	0,7	Collegatore telaio / pannello Verbinder Stützbock/Wand Frame/panel fixture Liaison châssis/panneau Sujeción armazón/panel
	650 010		CM	d= 1,6	0,2	Perno Bolzen Pivot pin Goujon Perno
	650 050		CM	d= 0,3	0,01	Copiglia Federstecker Safety pin Goupille Pasador
	580 516		CM		1,1	Graffa di ancoraggio Spannerkralle Tie-rod holder Etrier d'ancrage Grapa de anclaje
	580 513		CM	10	0,4	Piastra controplacca Gegenplatte Counterplate Contreplaque Contraplaca
	800 610		DW15/30	5	0,2	Dado esagonale Sechskantmutter Hex nut Ecrou hexagonal Tuerca hexagonal
	721 550		PS-UNI	90	13,3	Mensola di servizio uni Universal-Gerüstkonsole Universal bracket Console universelle Ménsula de servicio uni
	721 555		PS-UNI		1,8	Attacco mensola di servizio Gerüstkonsole-Anschluß Bracket attachment Fixation console Anclaje ménsula de servicio
	619 045	#	TS-450	450	275,5	Telaio di sostegno TS Stützbock TS TS support frame Châssis de reprise TS Armazón de soporte TS
	619 300	#	TS-300	300	212,3	
	619 350		TSL-300	300	124,0	Telaio di sostegno TSL Stützbock TSL TSL support frame Châssis de reprise TSL Armazón de soporte TSL
	740 011	#	MR-250	250	187,75	Mensola Rampante Kletterkonsole
	740 080		MR-180	180	153,3	Climbing bracket Console grimpante Ménsula rampante

	ART.	Comp.	COD	cm	Kg	
	561 000		MD-65	max. 1500 Kg	5,8	Gancio di sollevamento midi midi-Kranhaken midi crane hook Anneau de levage midi Gancho de elevación midi
	720 600		PT-600	min. 490 max. 620	39,9	Puntello regolabile Regulierbare Richtstütze Adjustable strut Étai réglable Puntal regulable
	720 450		PT-450	min. 220 max. 440	17,5	
	720 300		PT-300	min. 140 max. 280	12,0	
	720 150		PT-150	min. 75 max. 150	7,2	Braccio regolabile Regulierbarer Ausleger Stabilizer Bras réglable Brazo regulable
	721 105		PS-TO		1,6	Attacco puntello Richtstütze-Kopfstück Strut head Fixation étau Anclaje puntal
	721 310		PS		1,6	Base per puntello reg. Fußplatte für die Richtstütze Base for adjustable strut Base pour étau réglable Base puntal regulable
	580 800		CM		2,0	Catena per gancio di sollevamento Kranhakenkette Chain for crane hook Chaîne pour anneau de levage Cadena para gancho de elevación
	580 810		CM		0,3	Giunzione per catena Kettenverbindung Chain coupling Joint de chaîne Junta para cadena
	581 050		CM		10,44	Montante trasporto pannelli Transportwinkel Transport panel Cornière de stockage Montante de transporte paneles



	ART.	Comp.	COD	cm	Kg	
	140 110				75,0	Contenitore per attrezzi
	140 115				92,6	Kleinteilebehälter Tool case Boîte à outils Caja de herramientas
	860 200		DS	1 LT	0,8	Olio disarmante Ausschalöl Form oil Huile de décoffrage Aceite desencofrante
	860 000		DS	5 LT	4,8	Spruzzatore in plastica Sprühgerät aus Plastik Plastic sprayer Pulvérisateur plastique Pulverizador en plástico
	860 010		DS	5 LT	6,4	Spruzzatore in ottone Sprühgerät aus Messing Brass sprayer Pulvérisateur en laiton Pulverizador en latón
	860 100		DS		0,7	Tubo in gomma Schlauch Rubber tube Tube caoutchouc Tubo en goma
	860 110		DS		0,06	Ugello per spruzzatore Düse für Sprühgerät Nozzle for sprayer Glicieur pour pulvérisateur Boquilla para pulverizador
						WINSCHAL Software